

FETRON,TM solid state vacuum tube replacement

fet·ron (fet' rän) *n.* [ModE. < L. — *semiconductus* < *fetum* (? akin to *FET*, transistor), + *RON* (< Malay-sian), orig. with reference to a solid state tube replacement introduced by Teledyne Semiconductor in 1972] 1. An answer to improved performance and 100 year life of existing vacuum tube electronics gear 2. A cost reduction for companies maintaining large vacuum tube systems 3. A method of reducing the cooling requirements in buildings containing large quantities of vacuum tubes 4. A method of reducing electric bills due to elimination of filament current 5. [Adv.] The greatest thing since the winning of the West

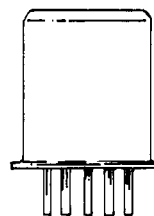

FETRON

Teledyne Semiconductor is a division of Teledyne, a diversified corporation with over \$1.2 billion annual sales, and products ranging from insurance to steel and electronics. The Teledyne Semiconductor division was formed in 1958. Its principle purpose was to develop and market the JFET (Junction Field Effect Transistor). Many high reliability solid state components have since been developed at Teledyne Semiconductor. These components are now used throughout the electronics industry in military, industrial, and consumer applications.

The Semiconductor division now has an extensive product line that includes bipolar transistors, digital and analog integrated circuits, hybrids, and JFETs. These product technologies, principally hybrid and JFET, have been applied by Teledyne Semiconductor in the development of the FETRON, a solid state device for direct vacuum tube replacement. FETRON production uses the same proven construction methods and quality control procedures as Teledyne's ultra high reliability, military grade electronic components. As a result, the FETRON has out-performed the vacuum tube in its own socket.

Although the required technology was available in 1968, the FETRON development didn't get under way until early 1970. This was partly due to the industry trend toward complete re-design of vacuum tube equipment with all solid state devices. In development of the FETRON, Teledyne's objective was to reverse this trend and develop an economical method for retrofitting vacuum tube equipment in the field.

FETRON,^{T.M.} solid state vacuum tube replacement

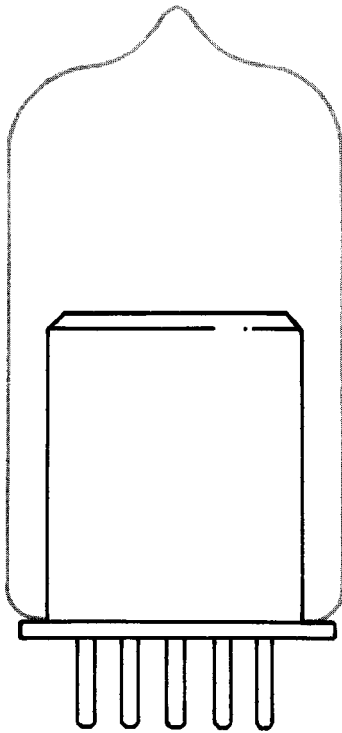

VACUUM TUBE TO FETRON

Prior to the development of the transistor, and particularly the high voltage JFET, electronic equipment for many applications was engineered with the vacuum tube as the principle active element. In spite of the instabilities and short life of the vacuum tube, much existing equipment, particularly telephone carrier equipment, is well designed and will last for many more years if properly serviced.

However, the servicing cycle for vacuum tube equipment is very expensive, requiring frequent adjustment and periodic tube replacement to minimize down time. As a result, most existing vacuum tube equipment is scheduled to be replaced by new all solid state equipment. But new equipment is also very expensive and requires large capitalization in most cases. Replacement of obsolete vacuum tube equipment has therefore been delayed.

As a solution to this problem, Teledyne has developed the FETRON for direct plug-in replacement of vacuum tubes in the field. This allows the vacuum tube equipment user to reap many of the benefits of all solid-state equipment without having to incur the expense of complete new systems. The FETRON provides improved equipment performance, and drastically reduces servicing costs and electric bills from the date of installation.

In high utilization equipment, such as telephone carriers, the FETRON can pay for itself within six months of installation. Dollar savings from the first year can then be applied toward more sensible long term equipment plans and for greater return on investment.

FETRON NOW

To date, the FETRON has been developed for replacement of pentodes and twin triodes. FETRONs are now available to replace many common tube types such as the 6AK5 and the 12AT7, described in a feature article of **Electronics Magazine**, April 10, 1972. Now in development are replacement types for thyratrons, tetrodes, various high frequency tubes like the 6BA6, and power pentodes such as the 6AQ5 and the 6V6.

The FETRON is not a universal replacement for vacuum tubes, and must be configured differently for certain applications. For example, the FETRON configuration will generally be different for a pentode amplifier and an oscillator. However, the number of replacement tube types and specific applications is growing rapidly, and may one day cover virtually every tube type and application.

The FETRON is currently used mainly in telephone communications systems. Several hundred thousand are now operating in telephone carrier equipment. FETRONs in the field have replaced the 407A, 408A, and similar types. Replacement types are under development for the 403A, 404A,

415A, and 396A tubes. Other replacement types will be developed as requirements are made known by potential users.

INSIDE THE FETRON

The FETRON is composed of one or more JFETs, a protective fuse, and R/C networks for tailoring to the required circuit performance parameters. The JFETs used in the FETRON are also used in high reliability missile systems, and many other applications. These are high volume, proven devices. A tantalum fuse is used, and thick film methods are employed for the R/C networks.

Using standard hybrid circuit techniques, the FETRON elements are assembled under ultra clean conditions. The FETRON elements are then attached to a substrate, after which the substrate is soldered to the header. Using gold wires, the chips and substrate pads are attached to the posts on the header. These posts extend through the header as the socket pins.

A 3/4" nickel-plated cap is cold welded to give the standard semiconductor type hermetic seal. The cap also minimizes device temperature and allows easy plug-in to tube sockets.

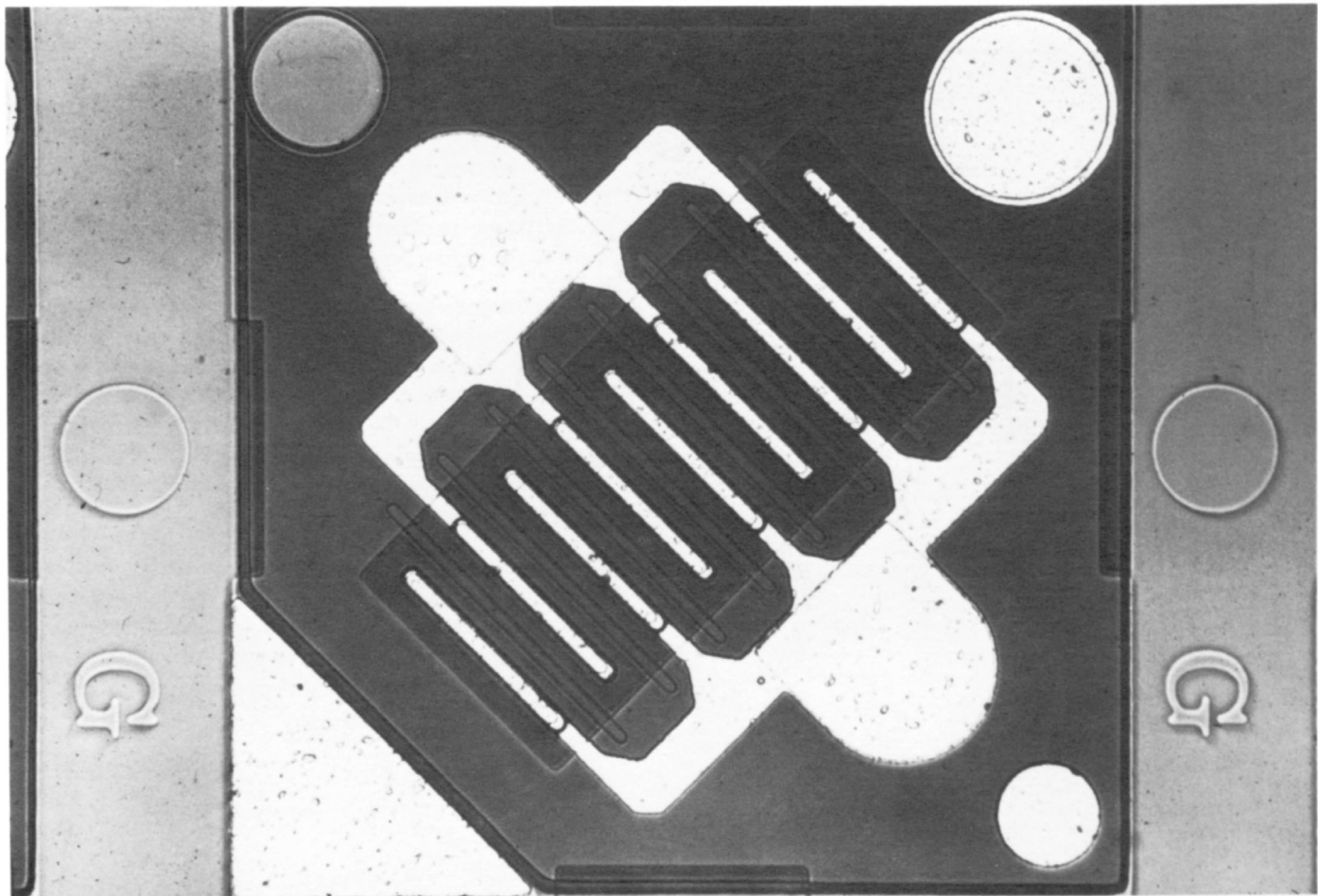

Figure 1. A Junction Field Effect Transistor (JFET). One of the JFETs used in the FETRON, and in volume production for high reliability missile systems and many other applications.

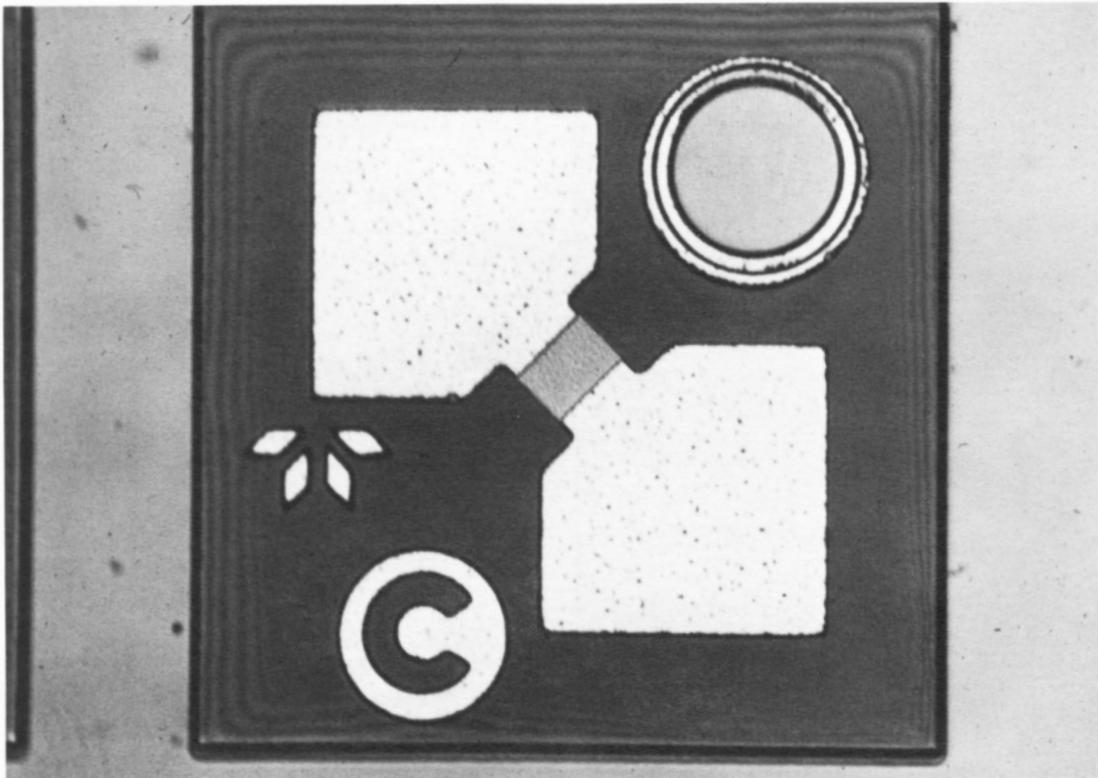

Figure 2. A Tantalum Fuse. The fusing device used for protection of other components in case of failure due to overload. The tantalum fuse, like other FETRON circuit elements, is made by well-established integrated circuit methods.

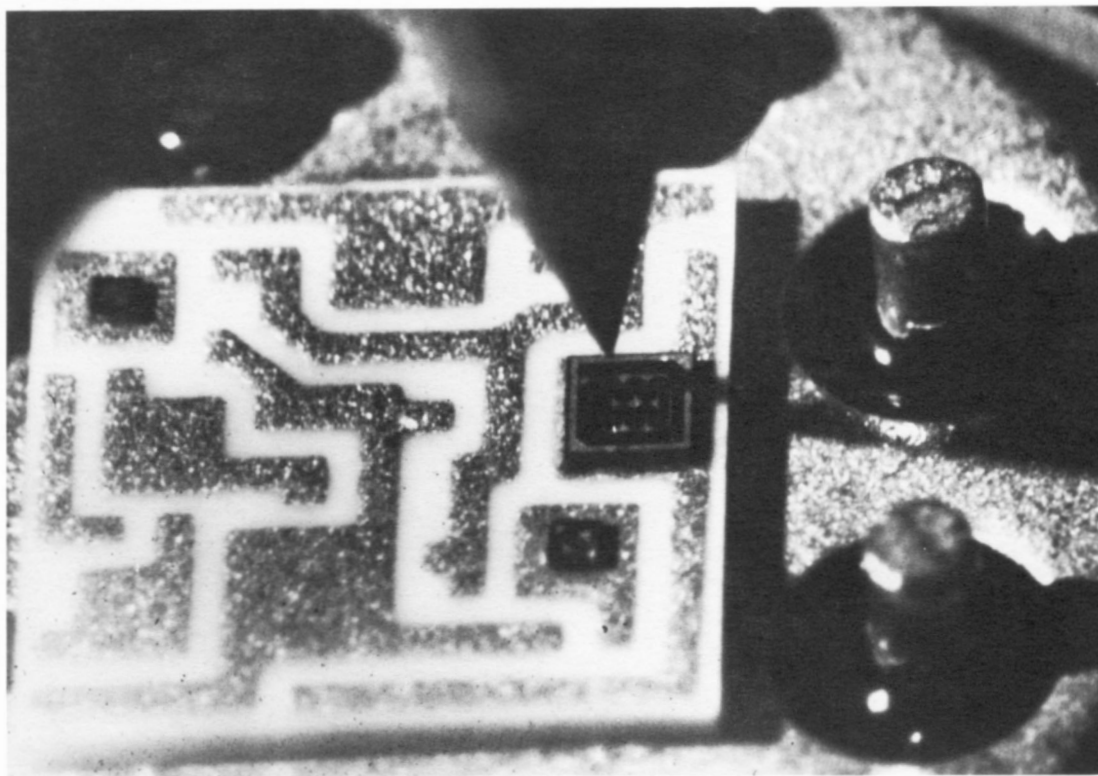

Figure 3. FETRON Circuit Assembly. FETRONs are assembled on a thick film substrate by well-established hybrid circuit methods. After bonding to the header, gold wires are connected from its pads to posts which extend through the header as pins for the vacuum tube socket.



Figure 4. FETRON Production. Methods used for assembly are the best industry quality control standards, MIL-STD-883. Assembly procedures are carefully planned and carried out under ultra-clean conditions to maximize FETRON reliability.



Figure 5. FETRON Assembly Steps. The FETRON thick film circuit is shown (1) as a clean substrate, (2) with conductive film, (3) with circuit etched, and (4) with circuit chips attached. The completed circuit is then soldered to the header and connected to the posts with gold wires. The header is then hermetically sealed with a nickel-plated cap.

HOW THE FETRON WORKS

The FETRON usually contains two JFETs connected in cascade to simulate the actual performance of a pentode or triode vacuum tube. The advantages of this configuration are:

1. The input characteristics are determined by the first device,
2. The plate voltage rating is determined by the second device, and
3. The Miller capacitance is minimized.

Since a screen grid is not needed by a FETRON, some circuits include R/C networks to simulate the equivalent circuit of the screen-plate circuit. A tantalum fuse is connected in the plate circuit to protect other circuit components in case of failure.

Using cascaded JFETs in combination with other elements, any number of different tube types can be simulated. The FETRON is most like a pentode in that the plate current is essentially independent of the plate to cathode voltage. The plate current of a triode, and its transconductance, are very much dependent on the plate to cathode voltage. The FETRON is therefore superior in principle to the triode, and usually provides improvement in circuit performance upon replacement.

However, the proper FETRON must be selected and trimmed for each application, to avoid saturation effects as determined from the load line analysis.

Because of characteristic similarity, a FETRON can very closely simulate the function of a pentode tube. The gain/phase relationships are almost identical for a FETRON and a

pentode. However, there are three important circuit improvements obtained with the FETRON. These are:

1. Reduced noise by several dB, and no microphonics,
2. Higher gain which is independent of screen voltage, and;
3. Lower distortion by typically 15dB.

The pentode generates distortion by cross modulation of higher harmonics, a result of its three-halves response relationship. The FETRON, however, is close to being a perfect square law device over most of its usable range, and generates almost no harmonics above the second. The FETRON must also be tailored for pentode operating conditions, but less critically than for the triode.

In general, the choice of FETRON depends on operating voltage and power levels, frequency range and whether an oscillator or an amplifier. Teledyne has analyzed the circuits on most telephone carrier equipment and other instruments such as Hewlett Packard VTVMs. Worst case analyses have been done on the carrier equipment by Teledyne together with different telephone companies. Teledyne has also formalized simple conversion procedures in most cases. The target ground rules for specific applications are:

1. No external components.
2. No re-wiring of equipment.
3. No power supply changes.
4. Plug directly into the tube socket.

These objectives have been achieved in almost every case. They make it easy for you to reap the benefits of the FETRON.

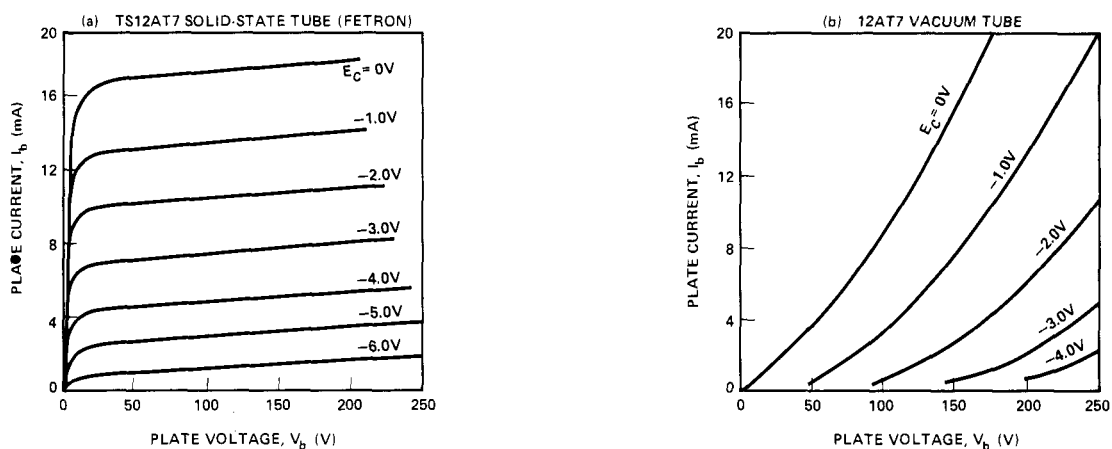

Figure 6. FETRON Compared with Vacuum Triode. The FETRON provides a plate current/voltage characteristic that is superior to the triode. Plate current in the FETRON is virtually independent of plate voltage. The plate current and transconductance of a vacuum triode is very much dependent on plate voltage. For example, with a 240 ohm load, a plate voltage change from 130V to 60V results in a plate current change from 8mA to 2.5mA. The same voltage excursion results in only μ A in the FETRON.

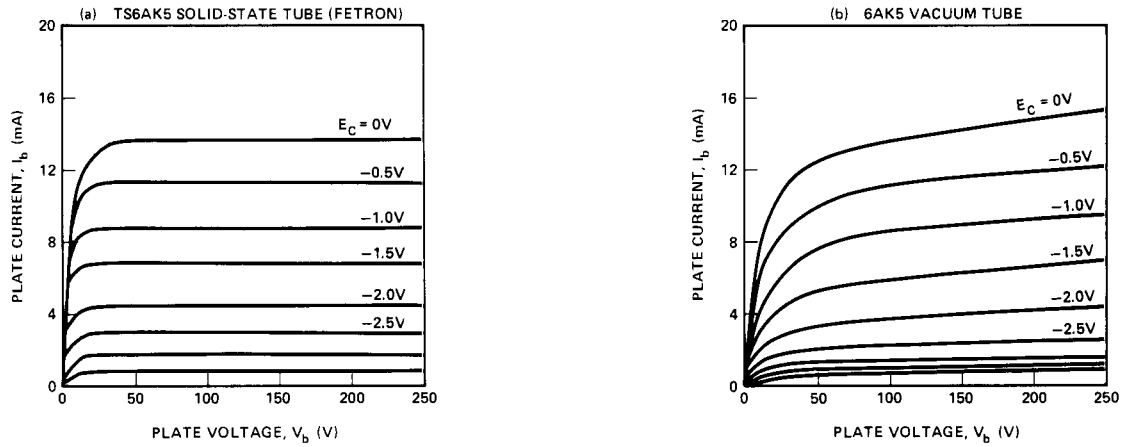

Figure 7. FETRON Compared with Vacuum Pentode. The FETRON is most like a pentode, but provides a superior plate current/voltage curve. The transconductance at the pentode is nearly independent of plate voltage, but depends on screen to plate voltage. The FETRON is independent of both. A plate voltage change from 130V to 60V causes a pentode plate current change from 10mA to 4mA. The corresponding FETRON current change is negligible.

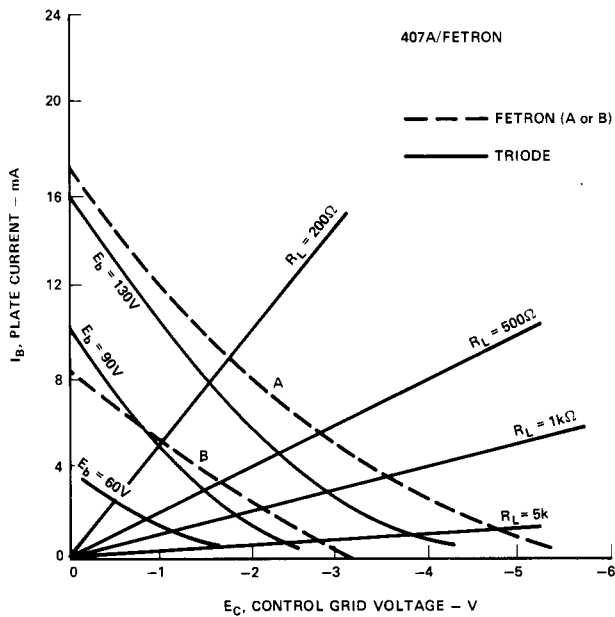

Figure 8. Transfer Characteristic, FETRON vs. Vacuum Triode. By JFET selection and trimming, any triode function can be generated. A load line analysis is conducted by Teledyne to prevent saturation when the FETRON is plugged into the tube socket. A 50kΩ load would saturate FETRON A, but not FETRON B.

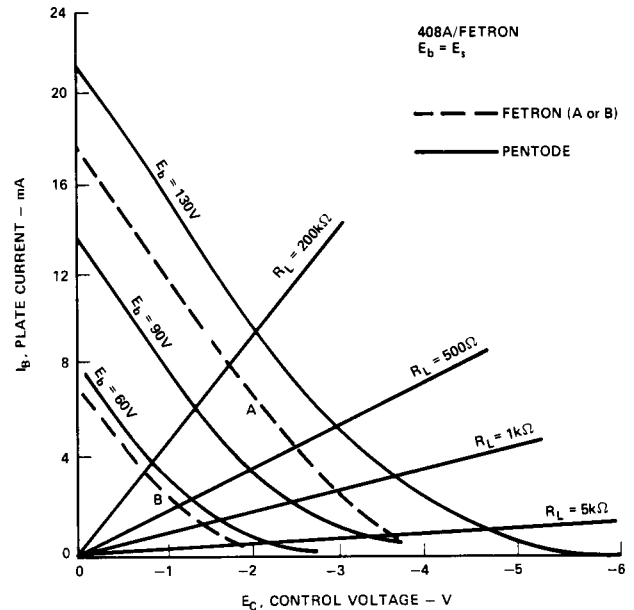

Figure 9. Transfer Characteristic, FETRON vs. Vacuum Pentode. Most vacuum pentode functions can be generated with a FETRON. The FETRON is less dependent on circuit voltage and generates less noise and microphonics.

CIRCUIT GAIN PHASE vs. FREQUENCY

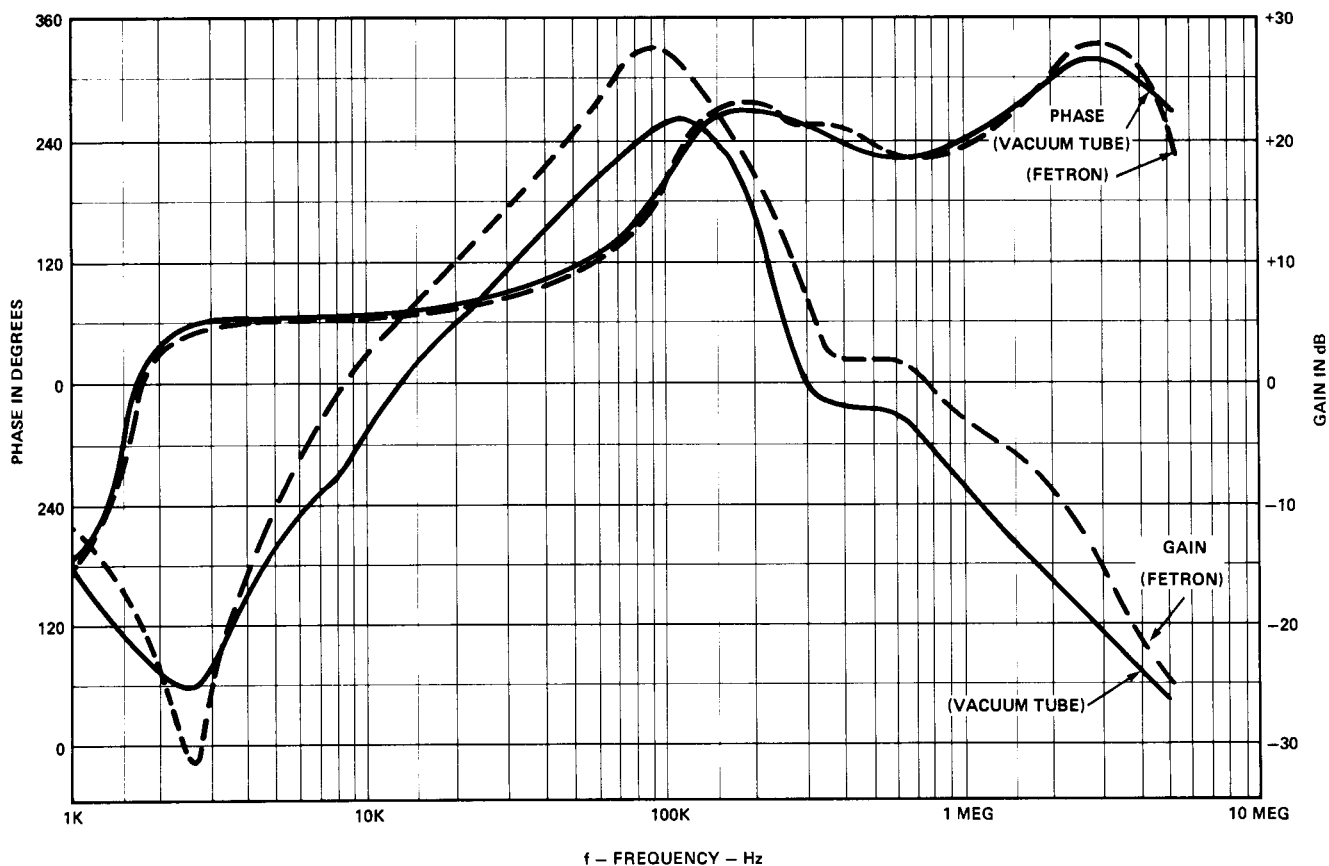

Figure 10. Frequency Response, FETRON vs. Vacuum Tube. The gain/phase curves for the FETRON and the vacuum tube are matched quite closely. No changes due to these functions are incurred. The FETRON reduces distortion due to upper harmonic by 15dB, a result of its true square law response.

FETRON BENEFITS

As a result of low initial cost of the FETRON and generous savings resulting from vacuum tube replacement, the FETRON is finding rapid and widespread acceptance. These cost savings result from the simple advantages the FETRON has over the vacuum tube. Primarily higher reliability, more stable operating characteristics, and lower power consumption. Add to this list the ease of replacement designed in by Teledyne, and the result is an irresistible opportunity for change.

Higher Equipment Reliability results from the lower operating temperature, less thermal wear on other parts, and the longer lifetime of the FETRON. Vacuum tubes have a useful life of only thousands of hours. Experience with FETRONs in the field has demonstrated a lifetime greater than one million hours, over a hundred years. The net result is extended equipment life, less down time and a savings of frayed nerves. The cost of standard industrial tube replace-

ments alone is about \$4.00 per year. Other components are estimated to be \$2.00 per year for each tube, resulting from thermal wear.

Maintenance Costs are drastically reduced since FETRONs do not require periodic replacement or frequent adjustment like the vacuum tube which begins to degrade immediately after installation. As a result, there is no change in signal transmission strength or quality degradation with time. A definite improvement in quality in most cases. Estimated savings for a typical thirty tube system are:

1. Local site — 3hrs x \$15/hr x 2 servicing/yr x 1/30 = \$3/tube/yr.
2. Remote site — 4hrs x \$25/hr x 2 servicing/yr x 1/30 = \$6.67/tube/yr.

Electric Bills are much lower because FETRONs use less than half the power of vacuum tubes. Air conditioning bills are lower too, and personnel efficiency goes up along with the

Table 1. Typical FETRON Savings, \$/yr/FETRON

Item of Savings	Remote/Commercial Tube Installation	Local/██████ Tube Installation	Your Installation
1. Reliability – 100 year FETRON	\$4.00	\$1.00	
2. Power Savings – on going operation	\$2.40	2.40	
3. Power Savings – new addition	\$4.80 (first year)	–	
4. Maintenance	\$6.67	\$3.00	
5. Loss of Revenue (poor service, etc.)	\$1.50	\$1.50	
6. Other Components – thermal wear	\$2.00	\$2.00	
7. Extended life of present equipment	???	???	
Total FETRON savings	\$16.57+?	\$9.90+?	

plant comfort index. Estimated power savings by replacement of a vacuum tube by a FETRON are:

1. Operating tube power – 1.9 W/tube x 9k hrs/yr x \$.01/kW hr = \$1.70/tube/yr.
2. Air conditioning, standby power, etc. – 0.9 W/tube x 9k hrs/yr x \$.01/kW hr = \$0.70/tube/yr.

Each equipment user has found different FETRON conversion priority and cost savings. Here are some examples of cost savings to set the wheels in motion.

- One area had maintenance problems and loud customer complaints on some repeater lines. All was quiet after conversion to FETRONs.
- A costly power panel replacement program for handling high current loads was cancelled due to the low current drain of FETRONs.
- After observing no drift in equipment calibration for a year after installation, numerous maintenance people were assigned other jobs.
- Instead of salvaging tube equipment in favor of short-lived new equipment, the older equipment lives on with FETRONs.
- After learning about FETRONs, additional batteries and diesel generator requisitions were cancelled. FETRONs eliminated the need.
- “Do I spend \$20,000 for power supplies and building additions?” Just \$1,600 worth of FETRONs deferred this expenditure for at least 5 years.
- Power plant additions totaling \$80,000 were deferred several years. A result of –48 volt savings accrued by installation of \$20,000 worth of FETRONs.
- One sizable telephone company when asked why they were so anxious for their FETRON delivery, indicated that they would be saving \$5,000 a day with FETRONs.
- Several remote sites in the Midwest used a twin DC to DC converter (two in case one failed), working off the –48V system. They were able to avoid increasing the –48V drain since filament current was eliminated with

FETRONs. As a result, a +130 supply and standby batteries were pulled out, making room for new carrier systems.

- One group installed FETRONs in equipment scheduled for removal within two years, still realizing a substantial savings with FETRONs. Unlike vacuum tubes that wear out, the FETRONs will be used elsewhere when the equipment is turned down.
- All groups like the advantage of immediate write-off maintenance money, rather than having to capitalize new equipment.
 “We can now meet the tighter standards imposed on us without huge expenditures.”

These profitable success stories are a result of careful engineering, and cooperative effort to solve the problems involved. The solution to these individual problems has resulted in a catalog of FETRON conversion kits available from Teledyne Semiconductor.

FETRON KITS

Numerous systems have been converted to FETRONs throughout the North American Continent. Other systems are in a field trial stage. Still others are in the prototype stage. As a result, a number of FETRON conversion kits are available in various phases of development.

Conversion of these systems available immediately:

- N1 Repeater (–130V or tandem)
- N1 Terminals (save > 200W)
- ON Carrier (stable, low W)
- O Carrier (stable, low W)
- O Repeater (low noise)
- HP 400 VTVM (low noise)
- E2, E3 Repeaters (simple conversion)
- V3 Voice Amplifiers (simple conversion)
- MF Receivers (all solid state)
- Lenkurt 45A Carrier (no drift)
- 43A1 Teletype (all solid state)

These systems are in field trials, available June, 1973:

Lenkurt 45BN Cable Carrier
Lenkurt 45BX Radio Carrier
ANI Identifier
Lynch B510 Carrier

These systems are in the prototype stage, some available data:

ON Junction
TD2 70MHz IF
Lenkurt 74, 70MHz IF
Lenkurt 4564 Repeater

Begin your investigations with the systems we have now. Teledyne stands ready to work with you on systems in development, or new systems to suit individual needs.

MAKE FETRONS PAY

If you have vacuum tube equipment in your facility, FETRONS will save money for you. The following is a suggested approach to determine how. It has been compiled from experience by applications of FETRONS at Teledyne.

1. Survey your equipment for the number and types of tubes, and types of equipment.
2. Consider setting up trial locations for field tests for the most pressing needs. Evaluate the results.
3. Teledyne will support your investigation with applications assistance. Take an in-depth look at the savings achievable with the FETRON.
4. Let Teledyne know your needs. They have experience where it counts and are anxious to help.

For immediate information or assistance, contact:

*Teledyne Semiconductor
1300 Terra Bella Ave.
Mountain View, California 94043
Phone: 415/968-9241*

FETRON[®] Solid State Vacuum Tube Replacement

TS6AK5 Series

Features

- ZERO WARM-UP
- NO MICROPHONICS
- REDUCED HEAT RADIATION
- MECHANICALLY RUGGED
- TRUE CUTOFF WHEN USED AS SWITCH
- NO SCREEN GRID POWER
- SEMICONDUCTOR RELIABILITY
- LOW NOISE/DISTORTION
- DIRECT REPLACEMENT
- NO HEATER OR SCREEN GRID POWER
- NO TRANSCONDUCTANCE
- DEGRADATION WITH TIME

Description

The TS6AK5 Series is a 7-pin miniature pentode in a metal hermetic sealed package. It is designed for direct replacement of conventional glass vacuum tubes where greater reliability, stability, and performance are desired. It can be used in RF or IF amplifiers/receivers, and in high-frequency wide-band applications up to 200 megahertz. It also excels in audio-frequency application exhibiting no microphonic noise and negligible 1/f noise. Low power consumption is ideal for mobile equipment tube replacement. Three types are available to meet differing applications.

Maximum Ratings

Plate Voltage	180 V
Grid – No. 2 (Screen-Grid) Voltage	N/C
Grid – No. 1 (Control-Grid) Voltage, Positive-bias value	0 V
Plate Dissipation	3.0 W
Screen Grid Dissipation	0 (N/C)
Plate Current	30 mA
Heater-Cathode Voltage	N/C
Operating Temperature Range	-25°C to +125°C

SIMILAR TS6AK5 FAMILY REPLACEMENT TYPES

6AG5, 6AK5W, 403A, 403B, 408A, 5591, 5654, 6028, 6096, 6186, 6968, 7543.

Foreign:

6F32, 12F31, DP61, E95F, EF90F, EF94, EF95, EF96, EF905, HF93, HF94, PM05, M8100, M8180.

Other Available FETRONS

2D21, 6AL5, 6AM6, 6AU6, 6BC5, 6BH6, 6CB6, 6CE5, 6J6, 12AT7, 12AX7, 404A, 407A, 415A, 5590, 5670, 5847, 6688, 7721, E180F.

Connection Diagram

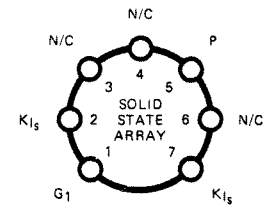

Physical Dimensions

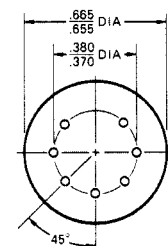
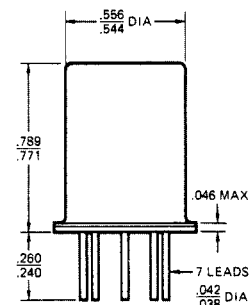

General Characteristics

Heater Voltage	N/C (Open)
Heater Current	N/C
Grid No. 1 to Plate Capacitance	0.02 μF
Grid No. 1 to Cathode Capacitance	4.0 μF
Grid No. 2 and Grid No. 3 Capacitance	N/C

Recommended Applications by Type

TS6AK5/A1 – This FETRON is designed for general purpose applications at operating frequencies up to 30 MHz. Typical applications include telephone type carriers, FM IF strips operating at 10.7 MHz, Hi-Frequency receivers through the 10 meter band, and DC applications such as analog computers. It is not recommended for use as an FM Limiter.

TS6AK5/A2 – This FETRON should be used in those 6AK5 circuits heavily biased for low plate current operation and having high plate load resistances, typically above 5000 ohms.

TS6AK5/A3 – This FETRON is designed for VHF operation between 30 and 200 MHz. It duplicates 6AK5 vacuum type operating dynamic characteristics up to about 300 MHz. When use in RF Tuners is anticipated, the receiver AGC range should be compared with the TS6AK5/A3 cutoff characteristics to ensure proper operation.

Operating Conditions and Characteristics (At 25°C unless otherwise specified)

Characteristic	Condition	TS6AK5/A1			TS6AK5/A2			TS6AK5/A3			Units	
		General Purpose			Low Current			Hi-Frequency				
		Min.	Typ.	Max.	Min.	Typ.	Max.	Min.	Typ.	Max.		
Plate Supply Voltage			130	180		130	180		130	180	V	
Grid No. 2 Supply Voltage			N/C			N/C			N/C			
Cathode Bias Resistor			200			200			200			Ω
Plate Resistance		0.5	5.0		0.5	5.0		0.5	5.0		M Ω	
Transconductance @ 1 kHz	$R_K = 200 \Omega$ $C_K = 4.0 \mu\text{F}$	3500	4500	7500	2000	3500	7500	2800	3400	6000	μMHOS	
Grid No. 1 Voltage	$I_D = 10 \mu\text{A}$		-5.0	-8.5		-2.5	-6.0	-3.5		-8.5	V	
Plate Current	$R_K = 200 \Omega$	4.0	7.0	10	1.5	3.0	4.5	2.8	4.0	8.0	mA	
Grid No. 2 Current			N/A			N/A			N/A			
Useful Frequency Limit			30			30			100	200		MHz
Grid No. 1 Current	$E_{c1} = -12 \text{ V}$		0.01	0.1		0.01	0.1		0.01	0.1	μA	
Case Operating Temperature	$P_p = 2.0 \text{ W}$		67			67			67			$^{\circ}\text{C}$
Noise Figure	100 MHz									2.0	dB	

NOTE: In series filament circuits, all tubes must be replaced by solid state replacements or appropriate resistor connected externally between pins 3 and 4. Some applications may require modified TS6AK5. Consult Teledyne Semiconductor for application information.

Typical Characteristics

TS6AK5/A1

PLATE CHARACTERISTIC

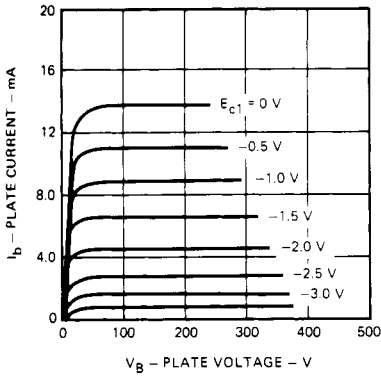

TRANSFER CHARACTERISTIC

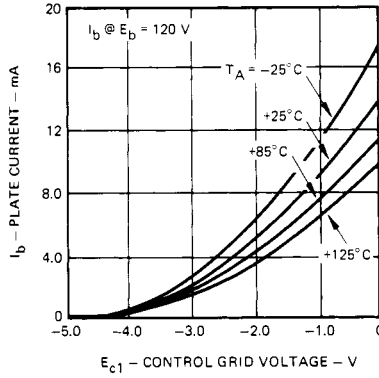

TRANSCONDUCTANCE CHARACTERISTIC

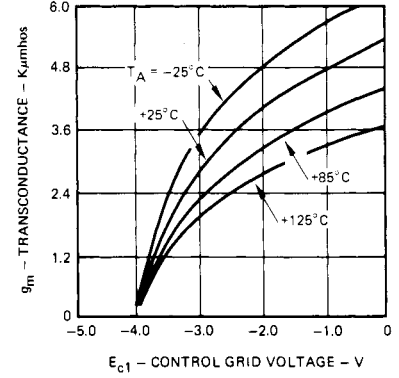

BY-PASSED PLATE CHARACTERISTIC

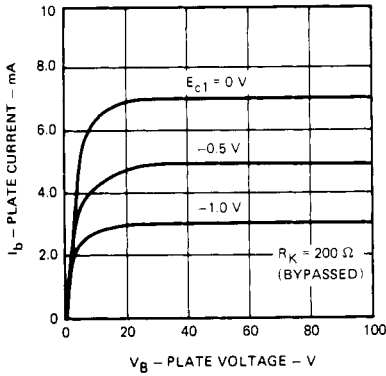
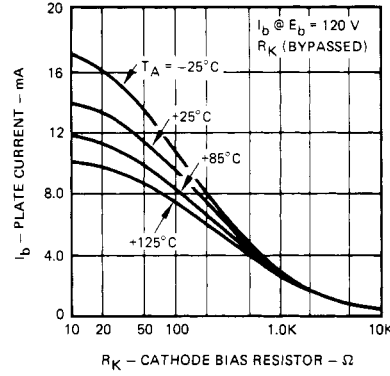
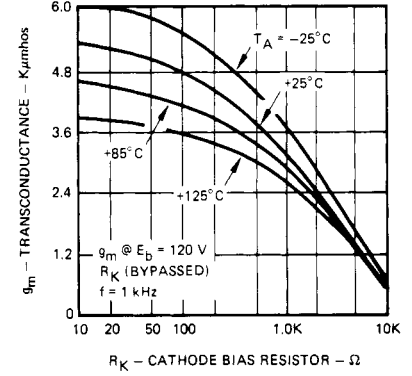

PLATE CURRENT VS. CATHODE BIAS



TRANSCONDUCTANCE VS. CATHODE BIAS



TS6AK5/A2 TS6AK5/A3

Typical Characteristics

PLATE CHARACTERISTIC

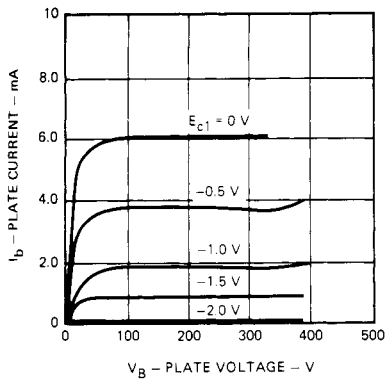

TRANSFER CHARACTERISTIC

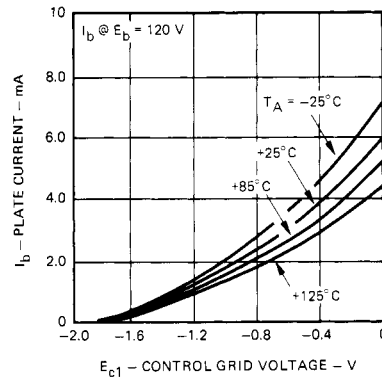

TRANSCONDUCTANCE CHARACTERISTIC

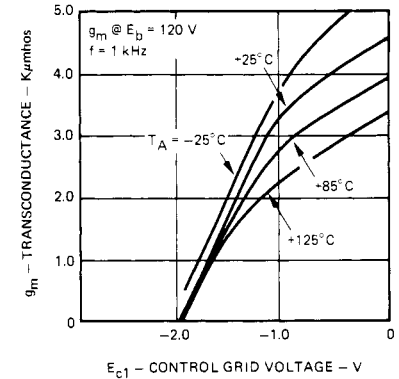

BY-PASSED PLATE CHARACTERISTIC

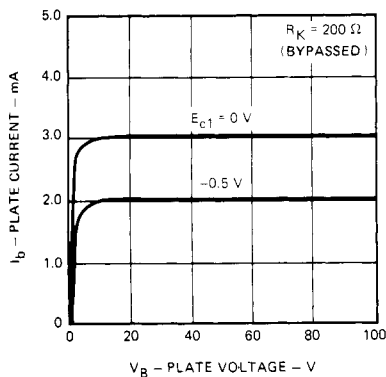
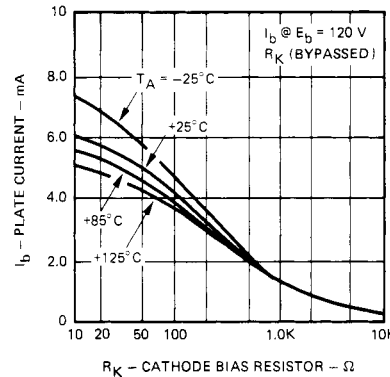
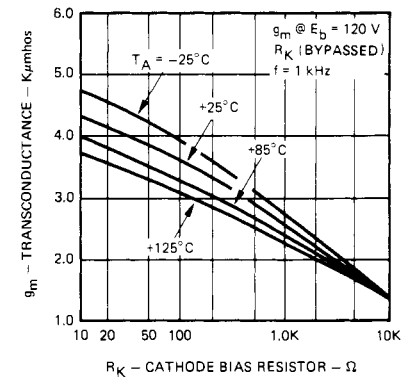

PLATE CURRENT VS. CATHODE BIAS



TRANSCONDUCTANCE VS. CATHODE BIAS



User's Guidelines

How to Test FETRONS

STEP 1

Determine the plate power dissipation from the circuit of the vacuum tube to be replaced. Use the highest ambient temperature in which the FETRON is expected to operate. Check the chart to ensure that the maximum safe operating point is not exceeded. The recommended maximum shown on the chart is established for a median lifetime of 300,000 hours (34 years).

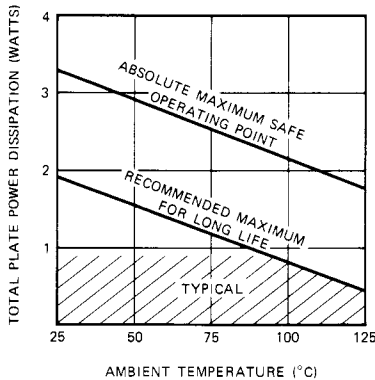

STEP 2

In series filament circuits, short circuit the filament socket pins (Nos. 3 and 4) and place a 39 Ω, 2 W resistor in series at a convenient location in the filament string. (Special FETRONS with pins 3 and 4 internally short-circuited can be supplied. Consult factory representative).

STEP 3

Check the plate load resistance. If it exceeds 5000Ω select Fetron type TS6AK5/A2.

STEP 4

Check the grid circuit AGC and cathode bias resistor. The FETRON should not be used with positive grid-to-cathode bias or in class C operation wherein grid-to-cathode peak positive bias exceeds +1.0 volts. If AGC bias voltage developed in the receiver exceeds -5.0 volts, it is recommended that AGC bias be divided down to -5.0 volts maximum.

The recommended equipment for testing FETRONS is a vacuum tube or semiconductor curve tracer, such as the Tektronix Model 575. Some mutual-transconductance type tube testers, such as the Hickok Model 539C or 752A, may be used with caution for limited testing but **DO NOT TEST FOR SHORTS OR GASSY TUBES. DO NOT TEST A FETRON WITH AN EMISSION TYPE TUBE TESTER UNDER ANY CIRCUMSTANCES.** Factory warranties are void for all FETRONS tested in such manner.

If a suitable test method is not available, the simple circuit below may be used.

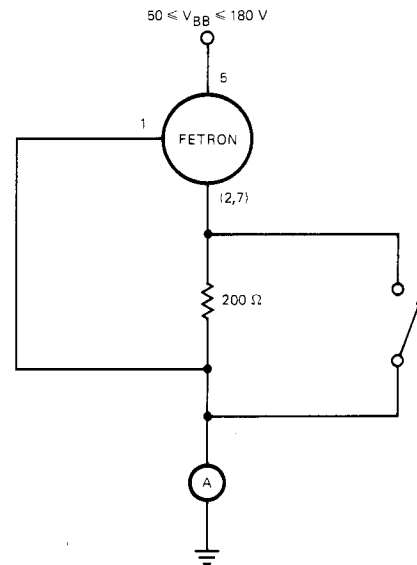

- Open the switch. Read cathode (plate) current, I_0 . Interpret grid voltage from the formula: $V_G = I_0 \cdot 200$.
- Close the switch and read cathode (plate) current, I_C .
- Interpret transconductance from the formula:

$$g_m = \frac{\Delta I_P}{\Delta V_G} \approx \frac{I_C - I_0}{V_G} \approx .005 \left(\frac{I_C}{I_0} - 1 \right), \text{ m Mhos}$$

TELEDYNE SEMICONDUCTOR

1300 Terra Bella Avenue, Mountain View, Ca. • Tel. (415) 968-9241 • TWX: 910-379-6494 • Telex: 34-8416
 Chausse de la Hulpe 181, 1170 Brussels, Belgium • Tel. (32) (2) 72 99 88 • Telex: 25881
 Albert Gebhardtstrasse 32, 7897 Tiengen, West Germany • Tel. (49) (7741) 5066 • Telex: 7921462
 Heathrow House, Bath Road, Cranford, Middlesex, England • Tel. (44) 01-897-2501 • Telex: UPQ 935008
 Nihon Seimei-Akasaka Bldg. (3F), 1-19, Akasaka 8-chome, Minato-ku, Tokyo 107, Japan • Tel. 03 405 5738 • Telex: 2424241 TPJ J

Teledyne Semiconductor cannot assume responsibility for use of any circuitry described other than circuitry embodied in a Teledyne product. No other circuit patent licenses are implied.



TELEDYNE SEMICONDUCTOR

TS6AM6*

*Note: Patent Pending

TS6AM6*

Solid State Vacuum Tube Replacement

Features

- ZERO WARM-UP
- NO MICROPHONICS
- REDUCED HEAT RADIATION
- MECHANICALLY RUGGED
- TRUE CUTOFF WHEN USED AS SWITCH
- 500 MHz PERFORMANCE
- NO SCREEN GRID POWER
- SEMICONDUCTOR RELIABILITY
- LOW NOISE/DISTORTION
- DIRECT REPLACEMENT
- NO HEATER POWER
- INTERNALLY RF SHIELDED
- NO TRANSCONDUCTANCE DEGRADATION WITH TIME

Description

The TS6AM6 is a 7-pin miniature pentode in a metal hermetic sealed package. It is designed for direct replacement of the conventional glass vacuum tubes where greater reliability, stability, and performance are desired. Application is primarily in Rf or If amplifiers/receivers especially in high-frequency wide-band applications up to 500 megahertz. It also excels in audio-frequency application exhibiting no microphonic noise and negligible 1/f noise. Low power consumption is ideal for mobile equipment tube replacement.

Maximum Ratings

Plate Voltage	300 Volts
Grid - No. 2 (Screen-Grid) Voltage	N/C
Grid - No. 1 (Control-Grid) Voltage, Positive-bias value	0 Volts
Plate Dissipation	2.5 Watts
Screen Grid Dissipation	0 (N/C)
Heater-Cathode Voltage	N/C
Operating Temperature Range	-25°C to +125°C

SIMILAR TS6AM6 FAMILY REPLACEMENT TYPES

6AK5W, 5654, 6AG5, 6BC5, 6AU6, 12AU6, 7543, 6BH6, 6DT6-A, 12AW6, 3AU6, 3BC5, 3DT6, 4AU6, 4BC5, 408A, 403B, 415A, 6DC6, 403A, 6CE5, 1220, 5591, 6096, 6968, 6136, 6186, 6265, 6661, 7693, 6028.

Foreign:

6F32, DP61, E95F, EF905, EF96, EF94, 12F31, HF93, HF94, EF90F, EF95, M8100, M8180, PM05.

Physical Dimensions

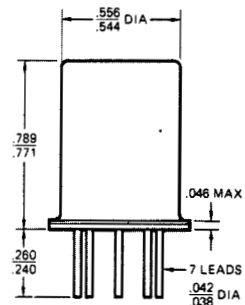

Connection Diagram

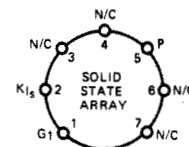

General Characteristics (Stated in conventional tube terminology)

Heater Voltage	N/C (Open)
Heater Current	N/C
Grid No. 1 to Plate Capacitance	0.02 μ F
Grid No. 1 to Cathode Capacitance	8.0 μ F
Grid No. 2 and Grid No. 3 Capacitance	N/C

Operating Conditions and Characteristics (At 25°C unless otherwise specified)

Characteristic	Symbol	Min.	Typ.	Max.	Units
Plate Supply Voltage	E_b		250	300	V
Grid No. 2 Supply Voltage	E_{C2}		N/C		
Grid No. 1 Voltage	E_{C1}		-2		V
Plate Resistance	r_p	0.5	3.0		$M\Omega$
Transconductance	gm	4000	6500	9000	μ mhos
Grid No. 1 Voltage for 10 μ A Plate Current	E_{C1}		-6.0	-10.0	V
Plate Current	I_b	4.0	10	13	mA
Grid No. 2 Current	I_{C2}		N/C		
Amplification Factor	μ	2000	19500		
Grid Current	I_{C1}		0.5	100	nA

Average Plate Characteristics

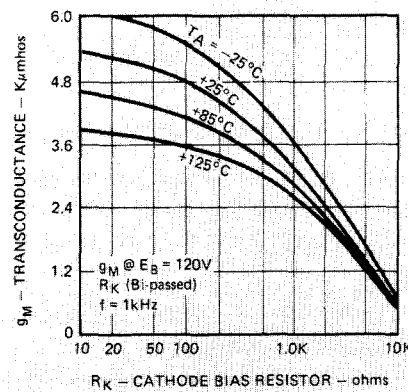
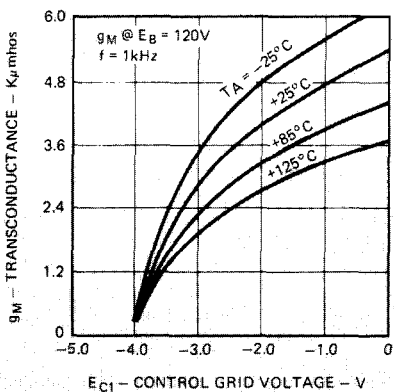
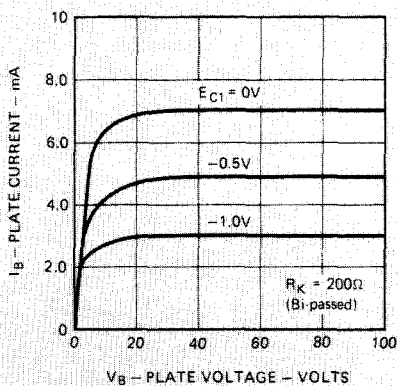
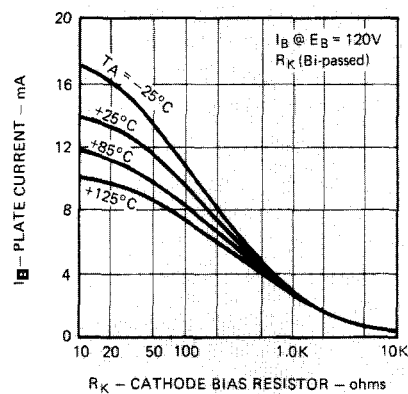
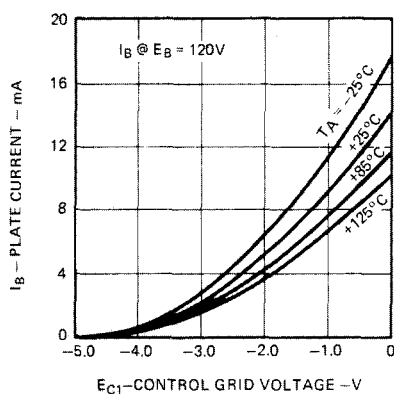
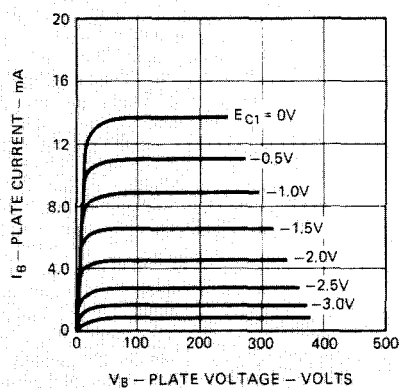

NOTE: In series filament circuits, all tubes must be replaced by solid state replacements or appropriate resistor connected externally between pins 3 and 4. Some applications may require modified TS6AM6. Consult Teledyne Semiconductor for application information.



TELEDYNE SEMICONDUCTOR

TS6CB6A*

*Note: Patent Pending

TS6CB6A*

Solid State Vacuum Tube Replacement

Features

- ZERO WARM-UP
- NO MICROPHONICS
- REDUCED HEAT RADIATION
- MECHANICALLY RUGGED
- TRUE CUTOFF WHEN USED AS SWITCH
- NO SCREEN GRID POWER
- SEMICONDUCTOR RELIABILITY
- LOW NOISE/DISTORTION
- DIRECT REPLACEMENT
- NO HEATER POWER
- INTERNALLY RF SHIELDED
- NO TRANSCONDUCTANCE DEGRADATION WITH TIME

Description

The TS6CB6A is a 7-pin miniature pentode in a metal hermetic sealed package. It is designed for direct replacement of the conventional glass vacuum tubes where greater reliability, stability, and performance are desired. Application is primarily in Rf or If amplifiers/receivers especially in high-frequency wide-band applications up to 175 megahertz. It also excels in audio-frequency application exhibiting no microphonic noise and negligible 1/f noise. Low power consumption is ideal for mobile equipment tube replacement.

Maximum Ratings

Plate Voltage	300 Volts
Grid - No. 2 (Screen-Grid) Voltage	N/C
Grid - No. 1 (Control-Grid) Voltage, Positive-bias value	0 Volts
Plate Dissipation	2.5 Watts
Screen Grid Dissipation	0 (N/C)
Heater-Cathode Voltage	N/C
Operating Temperature Range	-25°C to +125°C

SIMILAR TS6CB6A FAMILY REPLACEMENT TYPES

6AK5W, 5654, 6AG5, 6BC5, 6AU6, 12AU6, 7543, 6BH6, 6DT6-A, 12AW6, 3AU6, 3BC5, 3DT6, 4AU6, 4BC5, 408A, 403B, 415A, 6DC6, 403A, 6CE5, 1220, 5591, 6096, 6968, 6136, 6186, 6265, 6661, 7693, 6028, 6AM6.

Foreign:

6F32, DP61, E95F, EF905, EF96, EF94, 12F31, HF93, HF94, EF90F, EF95, M8100, M8180, PM05.

Physical Dimensions

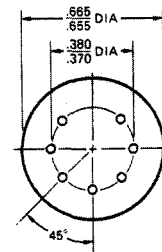
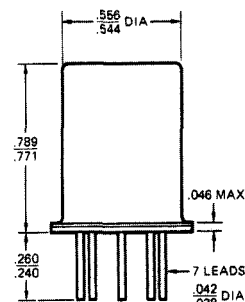

Connection Diagram

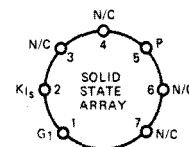

General Characteristics (Stated in conventional tube terminology)

Heater Voltage	N/C
Heater Current	N/C (Open)
Grid No. 1 to Plate Capacitance	0.02 μ F
Grid No. 1 to Cathode Capacitance	8.0 μ F
Grid No. 2 and Grid No. 3 Capacitance	N/C

Operating Conditions and Characteristics (At 25°C unless otherwise specified)

Characteristic	Symbol	Min.	Typ.	Max.	Units
Plate Supply Voltage	E_b		125	300	V
Grid No. 2 Supply Voltage	E_{c2}			N/C	
Grid No. 1 Voltage	E_{c1}		-3		V
Plate Resistance	r_p	0.5	3.0		M Ω
Transconductance	g_m	4000	7000	9000	μ mhos
Grid No. 1 Voltage for 10 μ A Plate Current	E_{c1}		-6.0	-10.0	V
Plate Current	I_b	4.0	10	13	mA
Grid No. 2 Current	I_{c2}		N/C		
Amplification Factor	μ	2000	21000		
Grid Current	I_{c1}		0.5	100	nA

Average Plate Characteristics

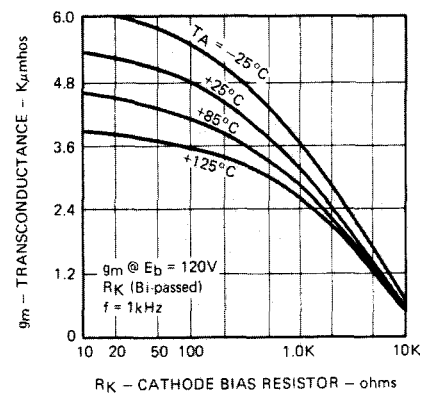
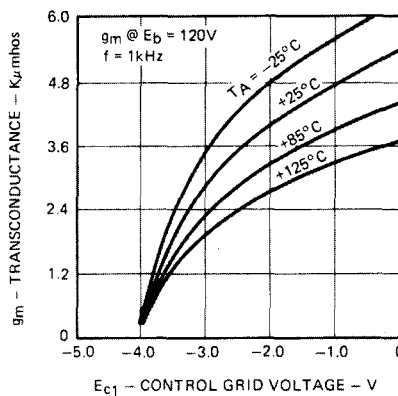
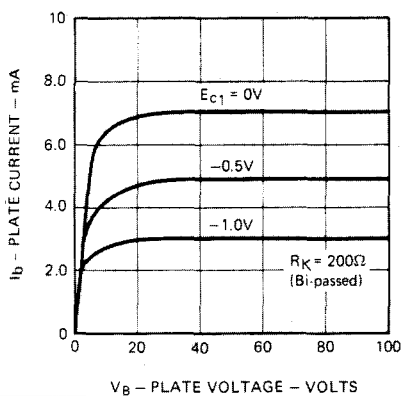
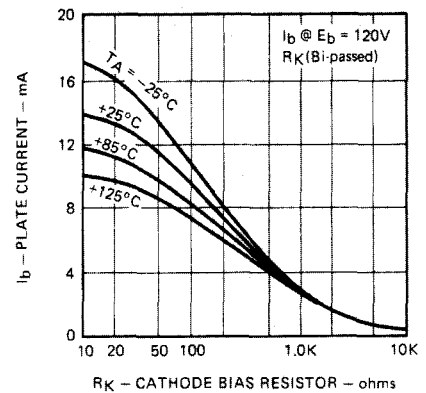
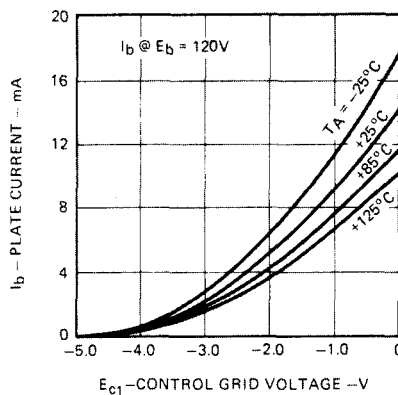
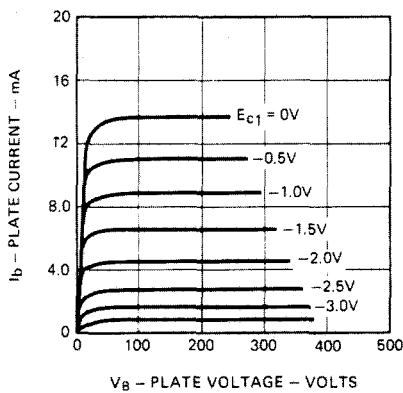

NOTE: In series filament circuits, all tubes must be replaced by solid state replacements or appropriate resistor connected externally between pins 3 and 4. Some applications may require modified TS6CB6A. Consult Teledyne Semiconductor for application information.



TELEDYNE SEMICONDUCTOR

TS12AT7*

*NOTE: Patent Pending.

TS12AT7* Solid State Vacuum Tube Replacement

Features

- ZERO WARM-UP
- NO MICROPHONICS
- REDUCED HEAT RADIATION
- MECHANICALLY RUGGED
- TRUE CUTOFF WHEN USED AS SWITCH
- NO SCREEN GRID POWER
- SEMICONDUCTOR RELIABILITY
- LOW NOISE/DISTORTION
- DIRECT REPLACEMENT
- NO HEATER POWER
- INTERNALLY RF SHIELDED
- NO TRANSCONDUCTANCE DEGRADATION WITH TIME

Description

The TS12AT7 is a 9-pin miniature double triode in a metal hermetic sealed package. It is designed for direct replacement of the conventional glass vacuum tubes where greater reliability, stability, and performance are desired. It is used as push-pull cathode-drive amplifier or frequency converter in the FM range, multivibrators or oscillators in industrial control devices, phase inverters, clamp circuit, relay drivers, and other diversified applications. The low power consumption makes it ideal for mobile equipment tube replacement.

Maximum Ratings

Plate Voltage	250 Volts
Grid Voltage, Negative bias value	-50 Volts
Plate Dissipation	5.0 Watts
Peak Heater-Cathode Voltage	N/C
Maximum Grid Circuit Resistance	2.0 Megohms
Operating Temperature Range	-25°C to +125°C
Plate Current	30 mA

SIMILAR TS12AT7 FAMILY REPLACEMENT TYPES

12AU7, 6BC8, 6BQ7-A, 6CG7, 6J6, 7AU7, 9AU7, 8CG7, 12AV7, 6DT8, 6EV7, 12BZ7, 6201, 6679, 6189, 5814A, 6680, 6072, 396A, 407A, 407B, 12AX7, 12AZ7, 6BZ7, 6BZ8.

Foreign:

B152, B309, B739, ECC81, ECC82, E81CC, E82CC, ECC801, ECC801S, ECC802, ECC802S, ECC186, B329, B749, M8136, M8162, QB309, QA2406.

Physical Dimensions

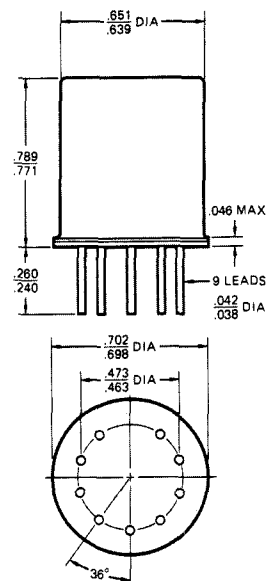

Connection Diagram

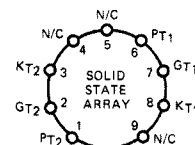

General Characteristics (Stated in conventional tube terminology)

Heater Voltage	N/C (Open)
Heater Current	N/C
Grid-to-Plate Capacitance (Each unit)	3.5 μ F
Grid-to-Cathode Capacitance (Each unit)	25 μ F
Plate-to-Plate Capacitance	0.1 μ F
Heater-to-Cathode Capacitance	N/C

Operating Conditions and Characteristics (At 25°C unless otherwise specified)

CHARACTERISTIC	SYMBOL	MIN.	TYP.	MAX.	UNITS
Plate Supply Voltage	E_b		130	250	Volts
Cathode-Bias Resistor	R_K		240		ohms
Peak A-F Grid-to-Grid Voltage	E_{C1C2}			20	Volts
Plate Resistance	r_p	50	250		Kilohms
Transconductance	g_m	2000	3000	6000	Micromhos
Amplification Factor	μ	100	750		
Grid Voltage for Plate Current of 10 μ A			-7.0	-10	Volts
Peak Negative Grid Voltage	E_C	-150	-300		Volts
Plate Current	I_b	4.0	9.0	15	Milliamps
Grid Current	I_C		2.0	100	Nanoamps
Tube Operating Temperature	O_T	-55	+75	+125	°Centigrade

NOTE: In most cases, the more pentode type characteristics will enhance present circuit performance. In a few instances, the user might need a selected range.

Average Plate Characteristics (Each Unit)

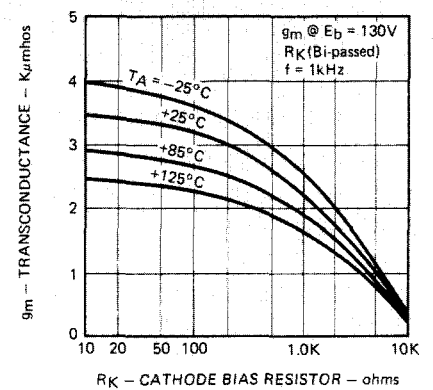
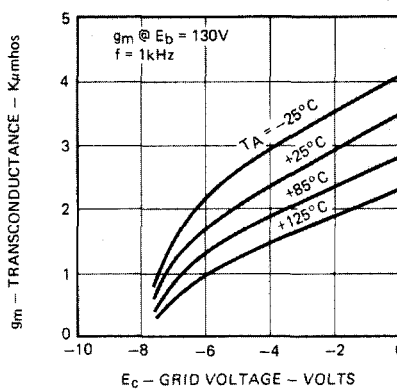
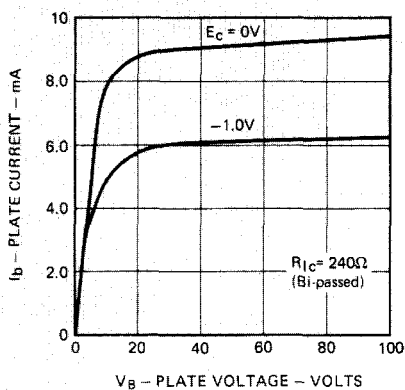
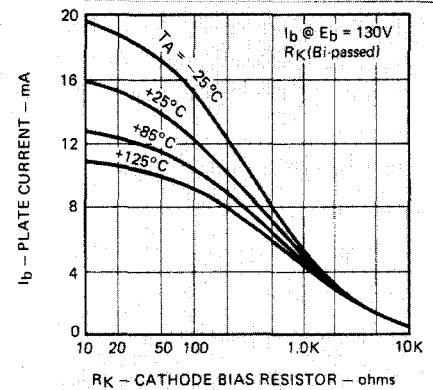
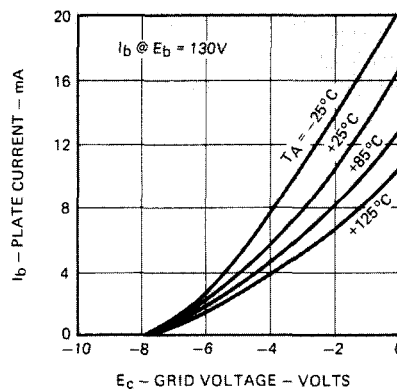
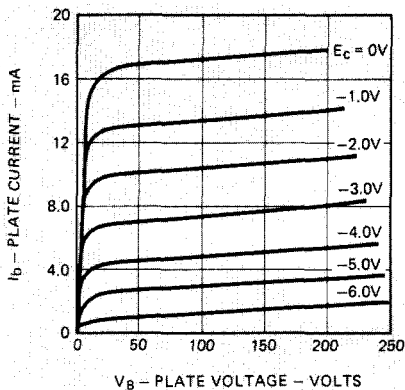

NOTE: In series filament circuits, all tubes must be replaced by solid state replacements or appropriate resistor connected externally between pins 3 and 4. Some applications may require modified TS12AT7. Consult Teledyne Semiconductor for application information.



TELEDYNE SEMICONDUCTOR

TS12AX7*

*NOTE: Patent Pending.

TS12AX7*

Solid State Vacuum Tube Replacement

Features

- ZERO WARM-UP
- NO MICROPHONICS
- REDUCED HEAT RADIATION
- MECHANICALLY RUGGED
- TRUE CUTOFF WHEN USED AS SWITCH
- NO SCREEN GRID POWER
- SEMICONDUCTOR RELIABILITY
- LOW NOISE/DISTORTION
- DIRECT REPLACEMENT
- NO HEATER POWER
- NO TRANSCONDUCTANCE DEGRADATION WITH TIME

Description

The TS12AX7 is a 9-pin miniature twin triode in a metal hermetic sealed package. It is designed for direct replacement of the conventional glass vacuum tubes where greater reliability, stability, and performance are desired. It is used as multivibrators or oscillators in industrial control devices, phase inverters, clamp circuit, relay drivers, and other diversified applications. The low power consumption makes it ideal for mobile equipment tube replacement. Application is primarily intended for replacement in circuits requiring unusually low plate current operation, such as those employing the type 12AX7 vacuum tube. For other applications, refer to the TS12AT7/A1 Fetron data sheet.

Maximum Ratings

Plate Voltage	250 Volts
Grid Voltage, Negative bias value	-50 Volts
Plate Dissipation	3.0 Watts
Peak Heater-Cathode Voltage	N/C
Maximum Grid Circuit Resistance	2.0 Megohms
Operating Temperature Range	-25°C to +125°C
Plate Current	5

SIMILAR TS12AT7 FAMILY REPLACEMENT TYPES

12AU7, 6BC8, 6BQ7-A, 6CG7, 6J6, 7AU7, 9AU7, 8CG7, 12AV7, 6DT8, 6EV7, 12BZ7, 6201, 6679, 6189, 5814A, 6680, 6072, 396A, 407A, 407B, 12AT7, 12AZ7, 6BZ7, 6BZ8.

Foreign:

B152, B309, B739, ECC81, ECC82, E81CC, E82CC, ECC801, ECC801S, ECC802, ECC802S, ECC186, B329, B749, M8136, M8162, QB309, QA2406.

Physical Dimensions

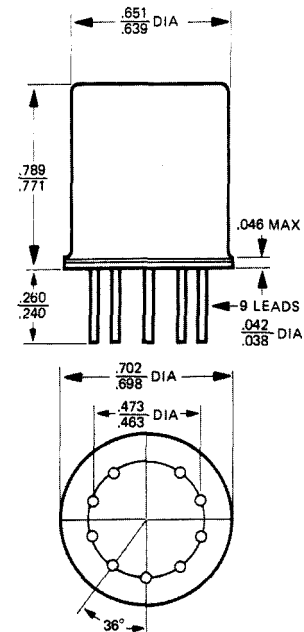

Connection Diagram

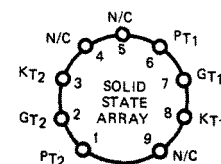

General Characteristics (Stated in conventional tube terminology)

Heater Voltage	N/C (Open)
Heater Current	N/C
Grid-to-Plate Capacitance (Each unit)	3.5 μ F
Grid-to-Cathode Capacitance (Each unit)	2 μ F
Plate-to-Plate Capacitance	0.1 μ F
Heater-to-Cathode Capacitance	N/C

Operating Conditions and Characteristics (At 25°C unless otherwise specified)

CHARACTERISTIC	SYMBOL	MIN.	TYP.	MAX.	UNITS
Plate Supply Voltage	E_b		130	250	Volts
Grid No. 1 Voltage	E_{C1}	-0.3	-2.5	-2.7	Volts
Peak A-F Grid-to-Grid Voltage	E_{C1C2}			20	Volts
Plate Resistance	r_p	50	250		Kilohms
Transconductance	g_m	300	750	1000	Micromhos
Amplification Factor	μ	150	188		
Grid Voltage for Plate Current of 10 μ A			-7.0	-10	Volts
Peak Negative Grid Voltage	E_C	-150	-300		Volts
Plate Current	I_b	0.2	0.8	0.9	Milliamps
Grid Current	I_C		2.0	100	Nanoamps
Useful Frequency Limit	f_T		30		Megahertz
Tube Operating Temperature	O_T	-55	+75	+125	°Centigrade

NOTE: In most cases, the more pentode type characteristics will enhance present circuit performance. In a few instances, the user might need a selected range.

Average Plate Characteristics (Each Unit)

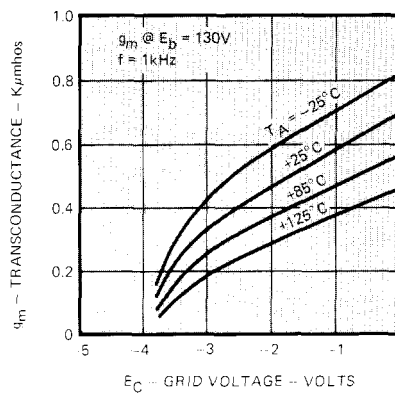
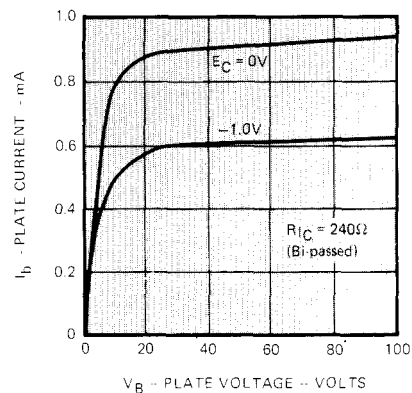
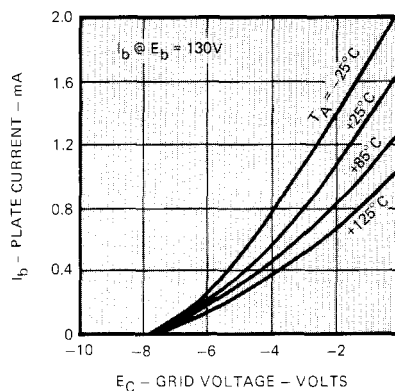
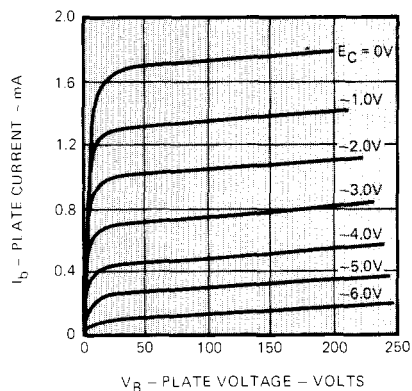

NOTE: In series filament circuits, all tubes must be replaced by solid state replacements or appropriate resistor connected externally between pins 3 and 4. Some applications may require modified TS12AT7. Consult Teledyne Semiconductor for application information.

**FETRON application
note 1**

**Vacuum tubes yield
sockets to hybrid
JFET devices**

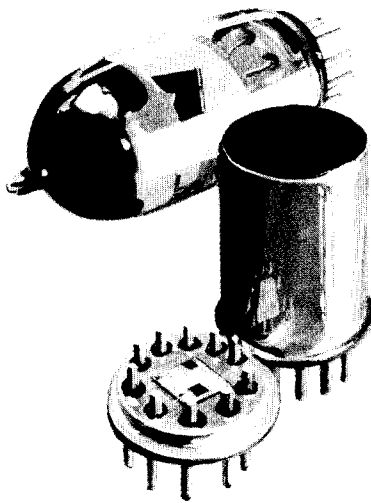

reprinted from ELECTRONICS MAGAZINE april 10, 1972

 **TELEDYNE SEMICONDUCTOR**

Reprinted with permission of Electronics Magazine; Copyright 1972, McGraw-Hill, Inc.

Technical articles

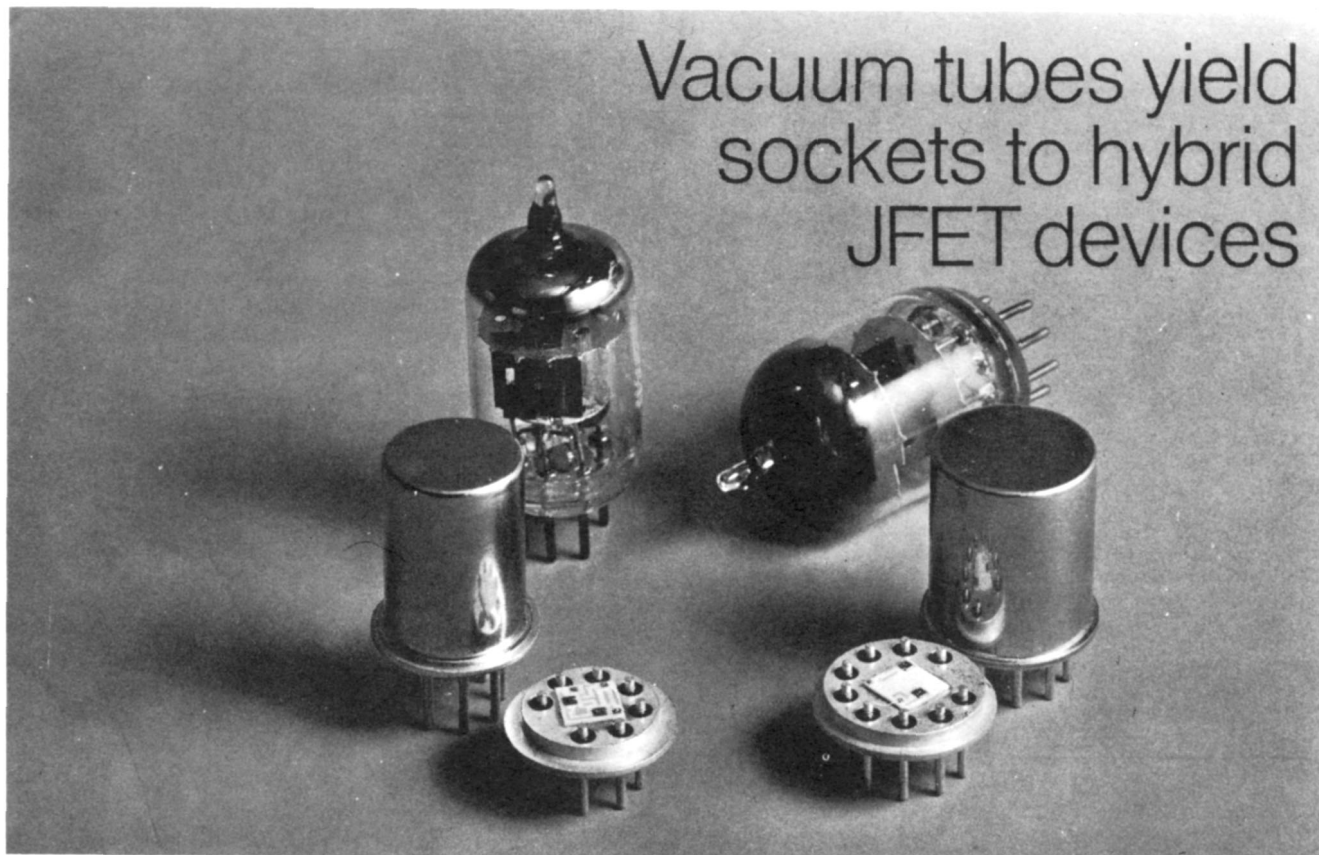

Vacuum tubes yield sockets to hybrid JFET devices

Thanks to high-voltage JFET technology, hybrid circuits called Fetrons exhibit virtually no aging, and also offer higher gain than do their vacuum tube counterparts

by Bruce Burman, *Teledyne Semiconductor, Mountain View, Calif.*

□ A junction-field-effect device called a Fetron has been developed that replaces a vacuum tube in a circuit directly, without requiring major modifications in the circuit. To withstand the tube's high voltage supply (the B⁺ voltage), the device is built with the high-voltage JFET technology that was developed more than five years ago for military systems requiring breakdown voltages of 200 to 300 volts.

The Fetron package can be either a single JFET or two cascode-connected JFETs in a hybrid IC. Each kind is now being built as one-for-one replacements for such widely used tubes as the 6AK5 and 12AT7, and each goes into an oversized IC metal can that has the same pin configuration as the tube it replaces.

Why the Fetron?

From a design point of view, Fetrons make good sense as replacements for tubes in much communication equipment:

■ Having no drift or aging, they can be locked in place for years, whereas the transconductance of many tubes degrades, often making monthly or quarterly adjust-

ments and periodic replacements mandatory.

■ Their improved performance includes higher amplification factors and lower noise than many tubes.

■ Their low-power operation derives from the absence of heater or screen grids and the power supplies that run them. They also operate at 65 degrees centigrade, instead of the 100° C of tubes.

■ The lifetimes of Fetrons are orders of magnitude longer than those of typical tubes—an estimated 30 million hours for Fetrons, 10,000 hours for tubes.

■ They're physically tough, too—there's no glass to break in a metal can.

Fetrons make good sense in terms of sales, too. Billions of tubes that the Fetron could replace are still being used in communication and radar equipment. For instance, the utility telephone network in the U.S. alone contains about 150 million tubes within the Fetron's capabilities, creating approximately a \$100 million-a-year market. And the maintenance bill of another major

Tubeless. Hybrid JFET devices shown above replace tubes on one-for-one basis. Called Fetrons, they plug into unchanged circuit.

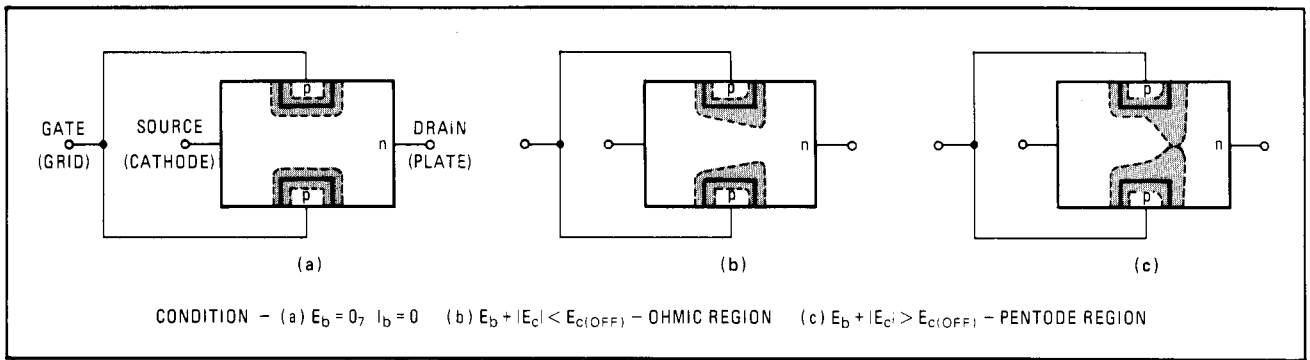

1. Brothers. JFET's elements are analogous to tube elements. The JFET source is comparable to the cathode, its drain to the plate, and gates to the grid. As the grid (plate) voltage goes negative, plate (drain) current drops. The gate's p-regions, growing into the channel, causes pinchoff, which is analogous to tube's cutoff.

telephone system's 50 million 6AK5 and 12AT7 tubes alone is estimated to be \$500 million a year. Less than half that amount would be required to replace all these tubes with Fetrons once and for all. Then there are probably another 70 million pentode and triode tubes in use in other equipment that is regularly maintained and regularly tuned—from mobile radios to various types of industrial equipment. The potential market grows toward a billion dollars, without even considering consumer equipment.

Viva la similarity

What makes the Fetron so attractive is that the JFET characteristics can be simply chosen to simulate a tube's dynamic performance. The circuit's normal trimmer components are used for high frequency tuning.

Basically, and very conveniently, a vacuum tube pentode and a JFET are brothers under the skin. Both are voltage-controlled devices and, if the differences between tube and transistor terminologies are ignored, both can be designed by using the same equations. Indeed, the operating polarities of n-channel JFETs and pentodes are identical, and they have similar output characteristics. If the JFET's drain and gate voltage are

varied, the resultant family of curves will look just like the old familiar pentode plate-voltage-versus-plate-current curves at different values of control-grid voltage.

Even the current-control mechanisms of the two devices are analogous. In a tube, the grid voltage controls the number of electrons emitted from the cathode that reach the plate. In the JFET, the gate potential modulates conduction in a channel that exists between source and drain, as is shown in Fig. 1. The top and bottom gates of the JFET are comparable to the grid of the tube, its source is comparable to the tube's cathode, and its drain is comparable to the tube's plate. As the gate (grid) voltage goes negative, drain (plate) current drops because the gate (grid) p-regions grow into the n-channel region until they eventually pinch off the channel. This pinchoff is analogous to tube cutoff.

Again, the output characteristics of JFET and pentode are very similar, as can be seen in Fig. 2. But since the JFET has no elements comparable to the pentode's screen grid and suppressor grid, it is closer to the simpler triode in construction.

Since a JFET doesn't need a heater, warmup is instantaneous. Also, because of its lower inter-electrode capacitance and low channel resistivity, it can operate at

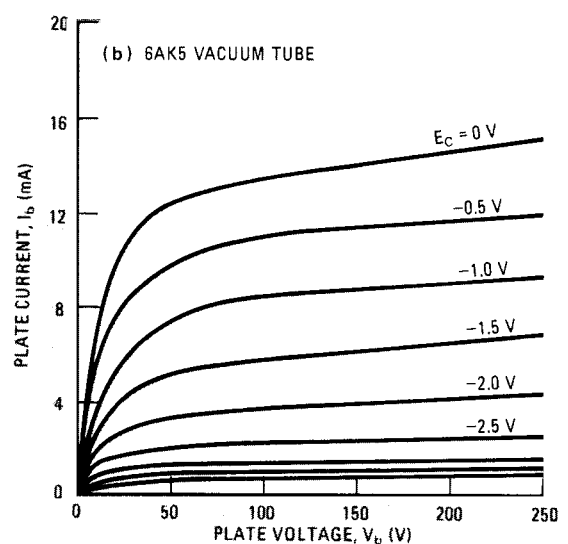
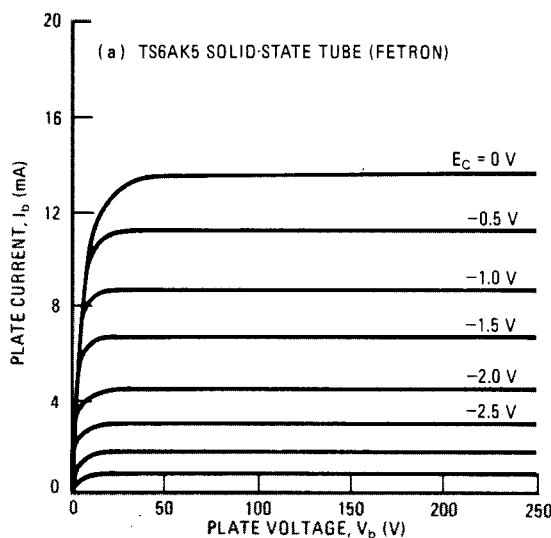

2. Equal but better. The JFET's output characteristics, although similar to those of a pentode, follow the square law more closely, and give a much cleaner on-off action, as is evident from the sharp cutoff.

much higher maximum signal frequencies than the tube, or at low frequencies with less distortion. The sharp cutoff evident in Fig. 2 gives a much cleaner on-off action, particularly in switching applications.

In short, the Fetron can be considered a better pentode than the vacuum tube pentode, because its drain output curves come much closer to the theoretical ideal.

And two JFETs are better than one

It requires two JFETs in a hybrid package to simulate the performance of one pentode. The JFET must withstand high plate voltage (see Fig. 2) to replace the tube directly. But there is no single high-voltage JFET with enough transconductance g_m to match that of the pentode tube. For example, to simulate the 6AK5 a transconductance of 3,500 to 7,500 micromhos at an operating current of 4 to 10 milliamperes is required.

Moderate g_m at high voltage is expensive to get with JFETs, since they must be physically large and of high-resistance material to yield high breakdown voltages. Then, too, the major barrier to high-frequency performance in semiconductors is the Miller effect—the gate-to-source capacitance. In an amplifier, Miller $C_{gs} = C_{gd}(1 + A)$. This is minimized in pentodes because of the extremely low plate-grid capacitance that exists because the control grid is shielded by the highly positive voltage screen grid.

To get a high-transconductance, high-frequency (low-Miller-effect capacitance) JFET device, it's necessary to bootstrap or cascode two of them (Fig. 3). In such a design, the input transistor is a small-signal JFET, like the 2N3823, chosen for its low capacitance and high g_m ; the output device is a high-voltage JFET, such as a 2N4882. The pair is assembled as chips and packaged in cans.

Smooth operator

The operation of the hybrid assembly is simple. The output JFET reduces the plate voltage to a safe level for the input JFET. The former JFET's drain is always connected to the high voltage—the equivalent plate connection in a Fetron—and its gate source connected to the input JFET's gate, which is tied to a low voltage or ground. With this arrangement the input capacitance of the device is just the fairly low capacitance of the input JFET, rather than the much higher capacitance associated with the large high-voltage chip.

With this arrangement assuring equal gains, the Miller-effect capacitance is equal to or lower than that of a tube pentode. The Fetron has only the 0.02-pico-farad drain-to-source capacitance of the high-voltage JFET in series with the drain-to-gate capacitance of the unity-voltage-gain low-voltage input JFET. The result: less than 0.02-pF Miller-effect capacitance.

Also, the cascode arrangement boosts the effective output impedance of the Fetron about an order of magnitude above that of a pentode tube. This not only greatly improves the pentode curves, but makes the circuit gain less dependent on Fetron characteristics.

The device's input looks like a reverse-biased semiconductor junction, which provides a very high resistance that's desirable in most applications. Significantly, the effective input impedance is an order of magnitude above a vacuum tube's. This enables a circuit to operate

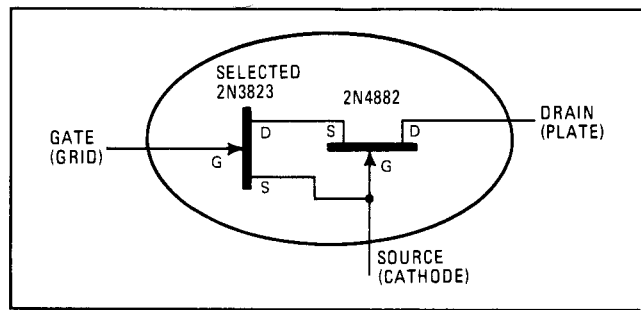

3. Gaining with cascodes. Most Fetrons are built with two JFETs in a bootstrap or cascode connection to achieve high-gain operation. Miller-effect capacitance is minimized by using a low-capacitance, high-gain input transistor, such as the 2N3823, connected to a high-voltage 2N4882 output device.

from a high-resistance source without being loaded down.

Amplification equations

The tube equations apply when the Fetron is plugged into a typical tube biasing network, like the one shown in Fig. 4. (Heater and extra grid connections are left open on the Fetron.)

At any control grid voltage, the plate current will be

$$I_b = I_{b0} \left[1 - \frac{E_c}{E_{c(\text{off})}} \right]^2$$

where

I_{b0} = plate current at $E_c = 0$ V

I_b = plate current at E_c voltage

E_c = control grid voltage

$E_{c(\text{off})} = E_c$ for 1 μ A of I_b

The change of plate current with grid voltage at a constant plate current gives the transconductance. By differentiating the equation for plate current with respect to control voltage:

$$g_m = \frac{\Delta I_b}{\Delta E_c} \Big|_{E_b = K} = g_{m0} \left[1 - \frac{E_c}{E_{c(\text{off})}} \right]$$

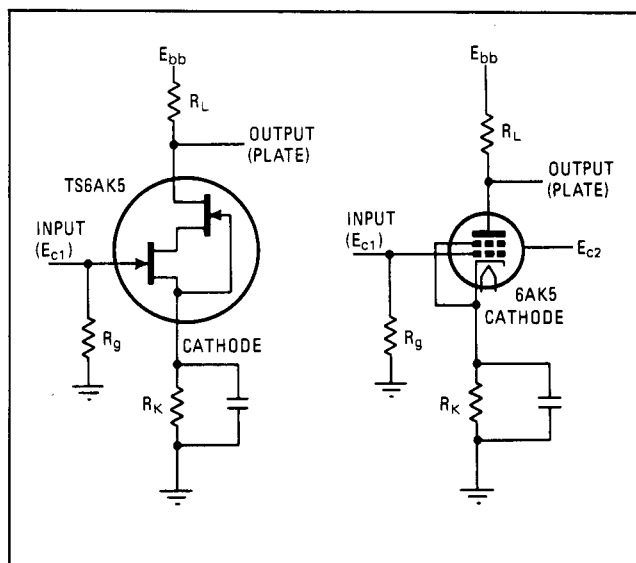

4. Same old circuit. A Fetron (TS6AK5, for example) can directly replace a tube (6AK5, for example) in an unaltered circuit. The heater and extra grid connections are left open on the Fetron.

where g_m = transconductance at operating E_c , and g_{m0} = transconductance at $E_c = 0$ v.

These characteristics give the solid-state device a true square-law characteristic and, because of this, very low harmonic distortion. Higher-than-second-order harmonics are virtually nonexistent.

In contrast, the vacuum tubes have a "three-halves-power" characteristic, and can generate substantially higher-order harmonics and intermodulation products. Interestingly enough, bipolar transistors have even more harmonics than the tube.

The Fetron's very high output impedance, analogous to a vacuum tube's plate resistance r_p , maximizes the voltage gain for a given load R_L . The voltage gain of an amplifier (see Fig. 4) can be expressed as:

$$A_v = \frac{\mu R_L}{r_p + R_L} = \frac{g_m r_p R_L}{r_p + R_L}$$

where $\mu = g_m r_p$ (μ is the tube amplification factor). But since r_p is much higher than R_L , the equation is simply

$$A_v \approx g_m R_L$$

At lower frequencies—less than a few megahertz—the simplified equation is more than 99% accurate for a Fetron.

Fitting the FETs

Versions of the device can be made for both amplifier and oscillator service. (The package for oscillator applications may include a small resistor or RC network for feedback and neutralization.) In practice, many FET characteristics are available, and single or JFET cascode pairs can be made to match the tube's current-voltage curves as shown in Fig. 5.

Although several approaches are available, about 80% of the general-purpose applications considered to date are satisfied by the simple FET # 1 approach. This

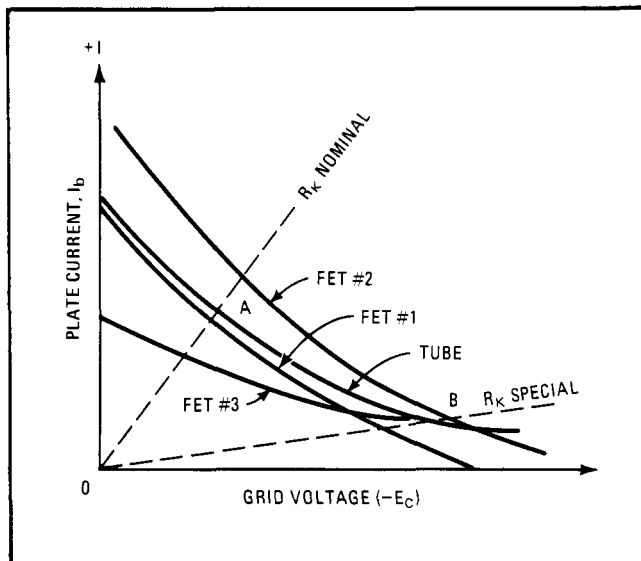

5. Choosing a Fetron. Several Fetron types are available to match a tube's application. If the tube operates around a fixed point, such as A, a JFET, such as FET # 1, is chosen. To match a tube that operates beyond a FET's cutoff, FET # 2 or FET # 3 is chosen: FET # 2 for high current before cutoff, FET # 3 for low, flat current.

Building the high-voltage JFETs

JFETs with breakdown voltages over 300 volts can be made by standard planar processing. But to achieve this high voltage, it is essential to attain the maximum breakdown field for silicon, about 30 volts per micron. Also critical is the epitaxial layer thickness and resistivity.

The channel is formed by the n-type epitaxial layer, which has a resistivity exceeding 5 ohm-cm. Since the channel region where pinchoff occurs is directly under the gate, doping levels in that region must be precisely controlled to limit spreading of the depletion region into the channel. The channel height depends on what final pinchoff voltage is desired.

The voltage from gate to source, V_{GS} , may be as large as -50 V. This V_{DG} value is required to enable the drain to withstand a voltage of up to 400 V. However, this high drain-to-gate voltage can only be achieved if the spacing of the gate, source and drain is held to very close tolerances.

Another difficulty is the need to shape the diffusions so as to minimize any surface field concentrations at the chip. Breakdown should occur in the bulk silicon, not at the surface. The substrate resistivity must be fairly high for good control of depletion spreading, as well. Otherwise, the channel might get pinched off with a very small charge in V_{GS} . At high operating voltages, V_{DS} can vary widely without any change in signal voltage, due to normal supply tolerances.

type of JFET is chosen if the application is unknown or if the device must operate around some nominal operating point A (in which case, the JFET curve closely approximates the tube curve over most of the control voltage range). In large-volume applications, where the exact operating point is known, FET # 1 can be selected at the factory to coincide exactly with a point anywhere near A on the tube's curve.

An operating point such as B beyond the normal FET cutoff can be matched by FET # 2 or FET # 3. FET # 2 would provide a higher current for the same control voltage, so it passes through B before cutoff. FET # 3 would have to be specially tailored for low, flat current characteristics, or for a narrow range of operation beyond the normal FET's cutoff. It would be a lower-transconductance, higher-cutoff JFET.

In simulating a tube, the dynamic characteristics as well as the operating point must be considered. Depending on the particular application, special attention must be given to transconductance, phase shift, phase margin, operating range, and neutralization requirements.

For amplifier operation, neutralization and operating range are the principle concerns. In most tube circuits, neutralization is used to nullify the effects of feedback capacitance during higher-frequency operation.

When used as an oscillator, the Fetron must provide for positive feedback between the output and input. An internal RC network within the device headers (Fig. 6) acts as a screen grid which is connected to the plate to assure direct replacement.

In Fetrons designed for amplifier operations, how-

ever, the RC network is omitted. If needed, a capacitor is added to provide the necessary frequency response. Characteristics of a properly trimmed TS6AK5 Fetron and the tube it replaces are listed in Table 1. Heater voltage is not specified, because those pins are not connected in the Fetron.

Note the great increases in amplification factor and plate resistance when Fetrons are used. The effect of these differences on the circuit is greatly improved sensitivity—about 4 to 5 decibels—resulting from the higher μ , lower noise, and low distortion.

Triode simulation

The Fetron will also perform well if configured as a triode, for the three electrodes of a single JFET directly simulate the latter's grid, cathode, and anode. But the JFET's much higher output impedance (hence higher gain) could cause an amplifier circuit to oscillate. Usually, however, the load resistance of a circuit is much smaller than r_p of the Fetron, and there is no problem.

The first Fetron triodes made were equivalents of the 12AT7 and Western Electric's 407 version, which has a 20-volt heater and slightly different pin-out. These Fetrons operate as twin triodes. Figure 7 and Table 2 show their characteristics compared to a single triode. Although the Fetron's transconductance is significantly lower (each of the triodes is a single high-voltage FET), its transconductance is the same as that of the twin triode being replaced. And the design equations given for pentode amplifiers also apply to the triode version.

True, the Fetron output characteristics approximates a pentode's, not a triode's. But it can be used to replace a twin triode—the more common triode application because two of the small inexpensive devices go easily into one glass tube envelope. It's generally not as good an electronic device as a pentode, though many circuit designers use them in cascade to get lower noise than obtainable with a pentode. Now, the Fetron triode upgrades typical circuit performance because of its excellent square-law characteristics throughout the con-

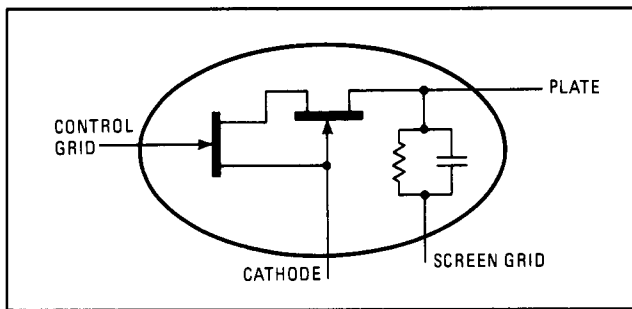

6. Farlung net. This oscillator network is used when Fetrons replace a pentode oscillator. The resistor and/or resistor-capacitor combination simulates screen-grid action. The network is included within the header, permitting 1:1 replacement.

trol voltage range. Power supply regulation can also be relaxed—triodes normally require well-regulated power supplies, because triode operating current depends on operating plate voltage, whereas the Fetron's does not (see Fig. 7a).

It's dependable

Besides replacing pentode and triode tubes, the Fetron gets higher marks in reliability than either. A high-reliability tube has a life expectancy of 5×10^4 hours (63% failure point). Preliminary data from burn-in and accelerated life tests on 1,000 Fetrons indicates a life expectancy of 3×10^6 hours, or 300 years. Of the 1,000 in the sample, 787 were screened by the type of power burn-in tests generally given high-reliability tubes, and were operated for 20 hours at twice normal dissipation (1,760 milliwatts). The failure rate, or dropout, was only 3.5%, a small fraction of the tube screening dropout rate.

In addition, some 2,500 Fetrons have been shipped to telephone companies for evaluation and trial applications. Many have been in use for as long as eight months, and to date, failures or degradations reported have been statistically unimportant.

Finally, another group was put in a 170° C oven and

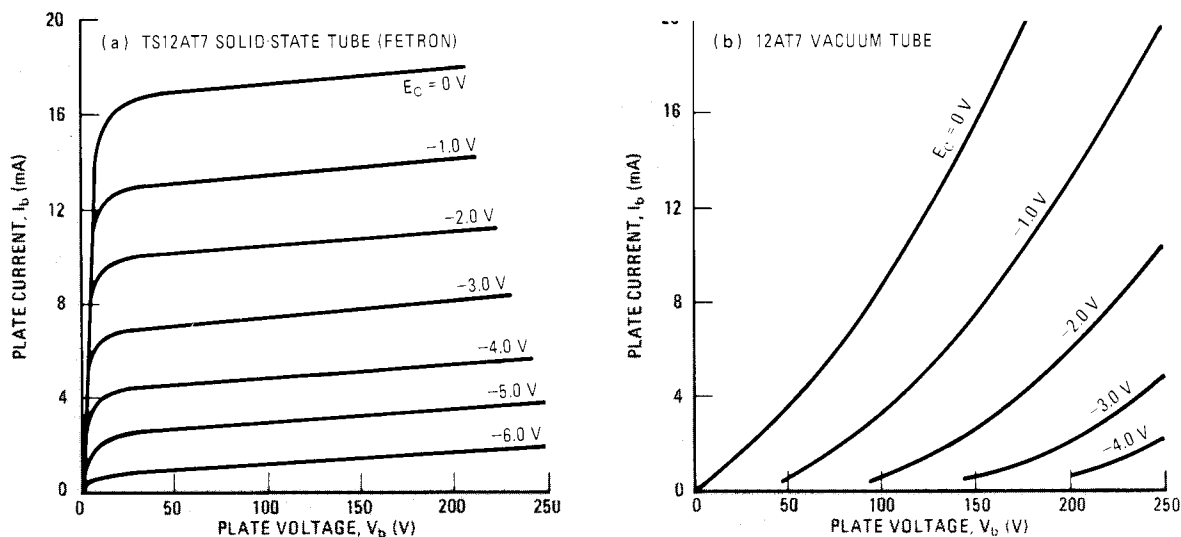

7. Just like a triode. Although the characteristics of a Fetron are different from those of a typical triode, they are similar to those of a triode pair and can be used wherever twin triodes are used. In fact, Fetrons were first designed to replace Western Electric's 407 twin triode.

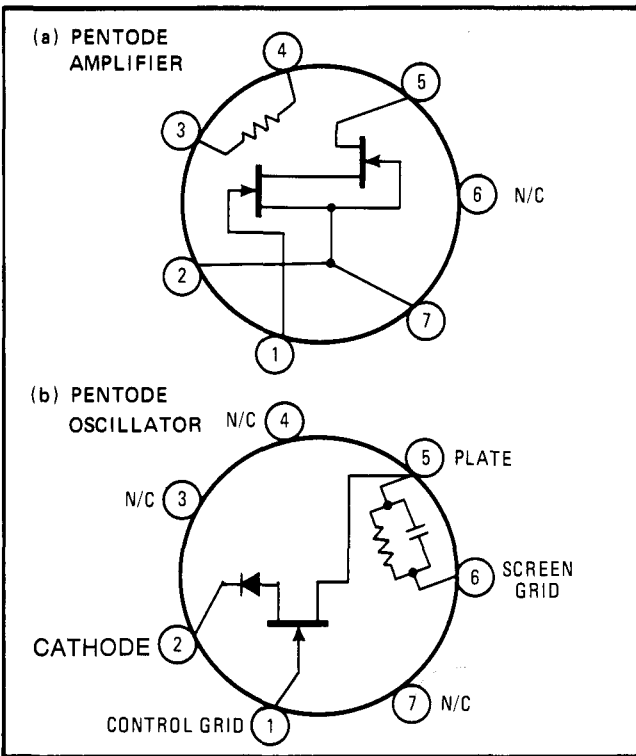

8. Different configurations. The internal configurations depend on whether the Fetron is destined for service as a pentode amplifier (a) or oscillator (b). For oscillator use, an internal RC network provides the required feedback when the Fetron is plugged into sockets.

powered at 1.2 W, a test that keeps the junction temperature at 215°C for 450 hours. One failed and one degraded (leaked), indicating device survival at 25°C for 10¹¹ hours.

From these destruction tests, it was found that although normal operating current is 7 mA, it generally takes a steady current above 30 mA, at 350 to 400 V, to induce failure. Surges up to 6 A can be withstood. Internal connections melt at 9 to 10 A, but fusing links can be built into the device so that if it does fail catastrophically, the circuit is protected.

Shock and other physical tests, comparable to normal

IC environmental tests, have also been made. The Fetron, because of its hard metal case, is virtually unbreakable. The case is a solid, deep-drawn steel cap welded to a large header. Before welding, the case is evacuated and backfilled with dry nitrogen.

Almost every general-purpose pentode and triode tube type, and various special-purpose ones, may be simulated with Fetrons, by selecting the appropriate FET pair and varying the internal connections and networks. Figure 8 shows two versions.

Variations include:

- The standard amplifier (6AK5 with 6.3-v heater). In amplifier circuits, a cathode resistor is commonly used to adjust the operating point. At frequencies up to 30 MHz, amplifiers don't need a neutralization network. At higher frequencies, an adjustable capacitor is usually available in the circuit. If not, a 2-pF capacitor may be added internally or externally.
- The oscillator, with the screen grid simulated and feedback to input provided by the connection to pin 6.
- The low-gain single-FET pentode.
- The twin-triode amplifier, for low-noise cascaded triode circuits.
- The twin triode, with an RC network inserted for voltage regulator circuits.

The Fetron pentodes have been operated to 500 MHz, exhibit lower i-f noise than the original tubes, and do not suffer from microphonics. Elimination of heater power, and usually all screen grid power as well, cuts supply drain and reduces operating temperature from well over 100°C for the tubes to about 65°C for the Fetron. After some eight months of trial operation, there has been no noticeable degradation in its transconductance.

Fetron triodes will generally be used in low-frequency applications. In most of these, their sharp cutoff improves on the original circuit performance. Naturally, such triodes have the same general noise and power-saving advantages as the Fetron pentodes.

Pacific Telephone Co. recently has converted to Fetrons on a trial basis in a number of repeater lines between San Francisco and Martinez, Calif. In addition, some of the channel equipment for multiplexing and

TABLE 1: TYPICAL PENTODE DEVICE CHARACTERISTICS - $R_K = 200 \Omega$, $E_b = 120 V$

PARAMETER	UNITS	6AK5 VACUUM	TS6AK5 SOLID-STATE
Plate voltage breakdown	V	350	350
Plate resistance	M Ω	0.5	5.0
Transconductance	μ mhos	5,000	4,500
Plate current ($R_K = 200 \Omega$)	mA	7.5	7.0
Grid voltage for $I_b = 10 \mu A$	V	-8.5	-5.0
Amplification factor	-	2,500	22,500
Input capacitance	pF	4.0	6.5
Output capacitance	pF	0.02	0.02
Useful frequency limit	MHz	400	600

TABLE 2: TYPICAL TRIODE DEVICE CHARACTERISTICS (EACH SIDE) - $R_K = 240 \Omega$, $E_b = 130 V$

PARAMETER	UNITS	12AT7 VACUUM	TS12AT7 SOLID-STATE
Plate voltage breakdown	V	400+	350
Plate resistance	k Ω	15	250
Transconductance	μ mhos	4,000	3,000
Plate current ($R_K = 240 \Omega$)	mA	5.0	9.0
Grid voltage for $I_b = 10 \mu A$	V	-7.0	-7.0
Amplification factor	—	60	750
Input capacitance	pF	2.2	25
Output capacitance	pF	1.5	3.5

demultiplexing in a carrier office is now equipped with Fetrons.

What next?

There are numerous tube types that can be made with the basic Fetron designs. Types such as the 6JC6 and 6EW6, which have transconductances in the vicinity of 25,000 micromhos and plate currents in the 40-mA range and which have already been made, can be combined with the 6AK5, 12AT7, and their derivatives so as

to make Fetron versions of the great majority of popular tube types. Next to be tackled will be the power pentode devices, such as 6AQ5, 6V6, and remote cutoff pentodes, such as 6BA6. Indeed, with volume production and some packaging changes, the Fetron could go on to become a low-cost replacement for most tubes. □

REFERENCES

1. F. E. Terman, "Radio Engineers' Handbook," 1st ed., McGraw-Hill Book Co., 1943, p.469.
2. R. L. Berger, "The Direct Replacement of Pentode Vacuum Tubes with Cascode Field Effect Transistors," Mid-America Electronics Conference, Kansas City, Mo., October, 1971.

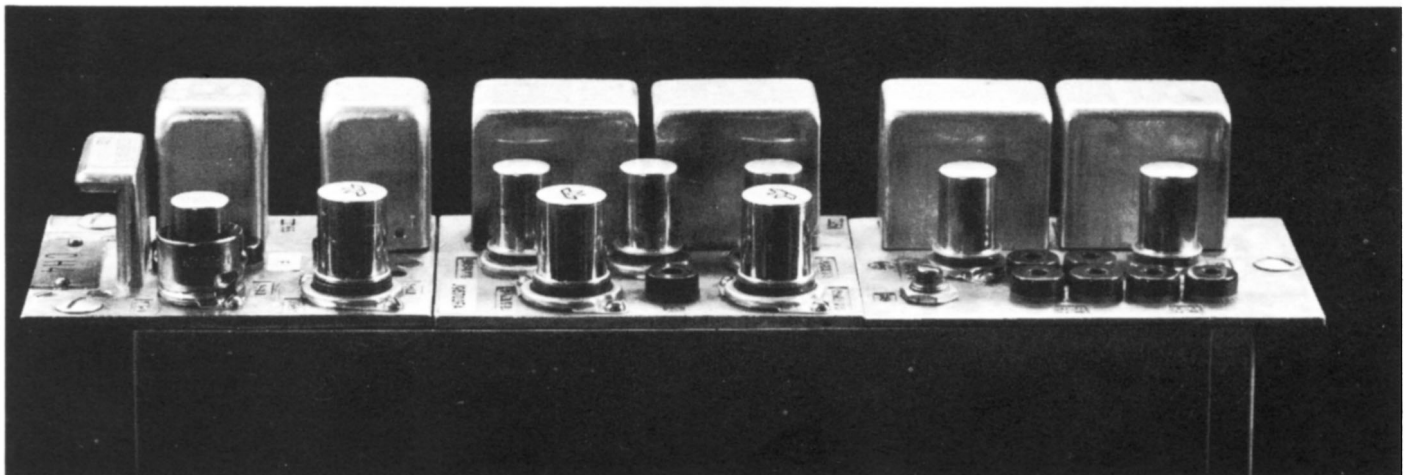
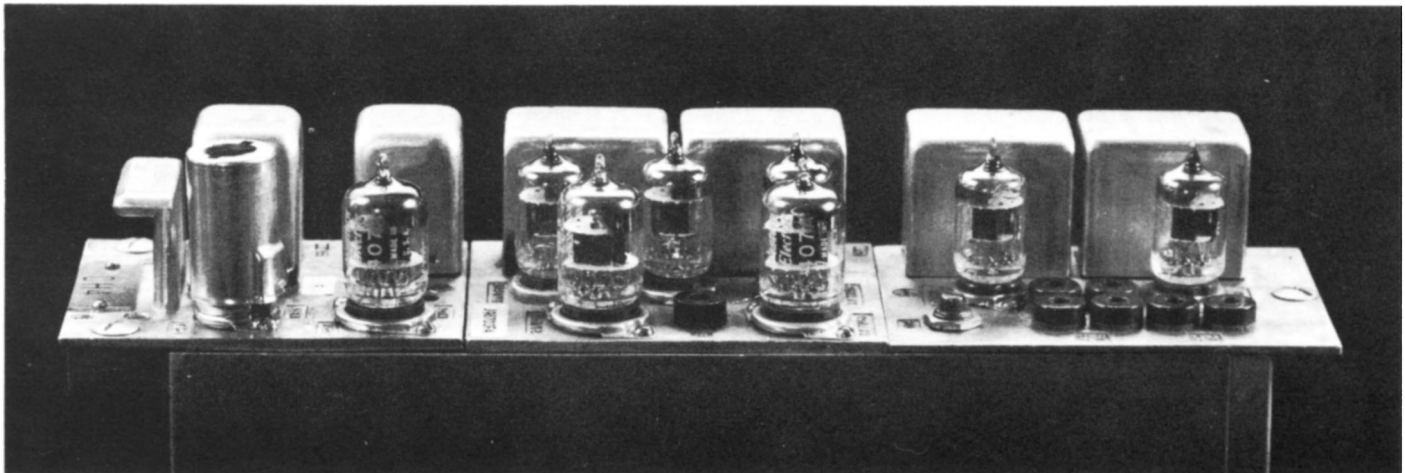

9. Finding their place. In the above amplifier, all the 6AK5 and 12AT7 tubes have been replaced with equivalent Fetrons.

february 1974

application note

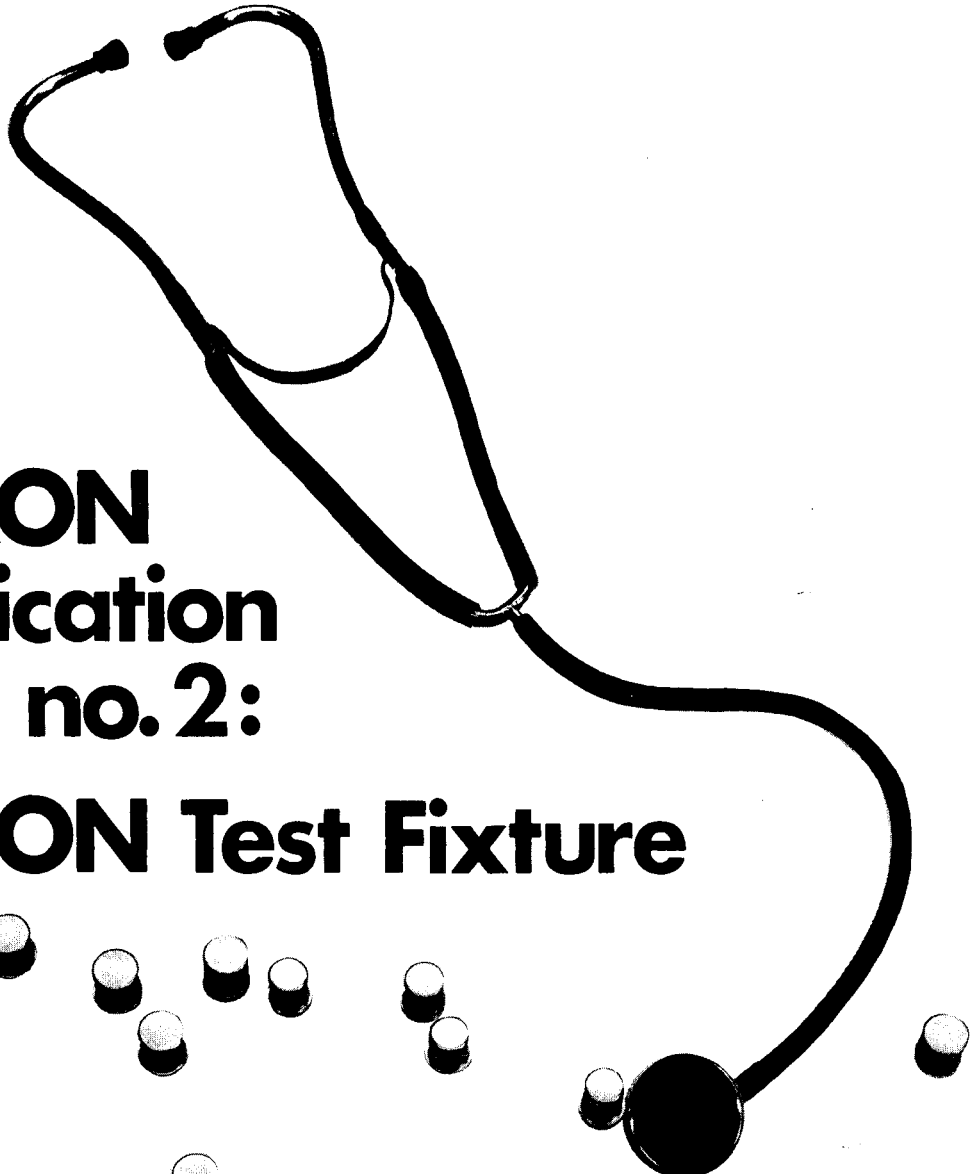

FETRON
application
note no. 2:

FETRON Test Fixture

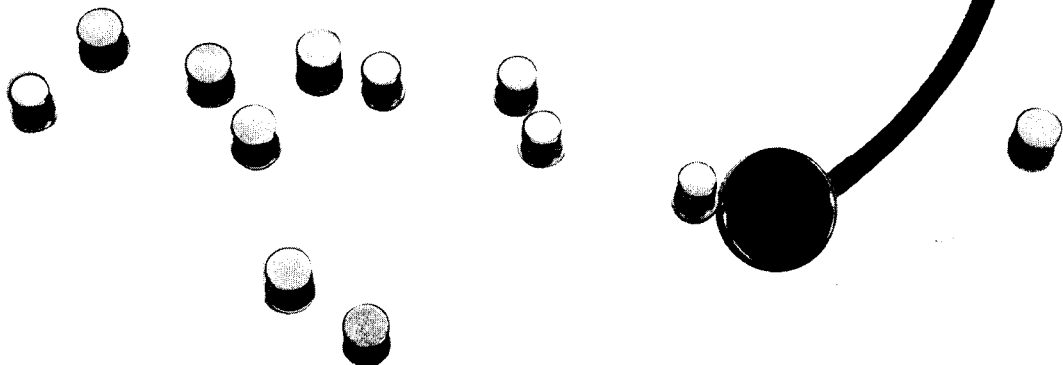

A Simple Fixture for Field Testing FETRONs

Assemble the test jig shown in Figure 1 which is wired according to the schematic shown in Figure 2.

After attaching a power supply and connector, the FETRON is inserted in the socket according to the socket callout in Tables I or II. With the cathode resistor switch in the "in" position, read the current referred to as I_{dsr} in Tables I or II. To show that the device has gain, throw the cathode resistor switch to the "out" position. The current should roughly double in value. A good approximation of the transconductance may be computed at this point using the equation:

$$g_m = \frac{\frac{I_c}{I_o} - 1}{R_K}$$

Where $R_K = 200\Omega$ for S1 and 240Ω for S2 and S3.

I_c = Drain current with cathode bypass switch (S1, S2 or S3) closed.

I_o = Drain current with cathode bypass switch open.

This equation is verified in Appendix I.

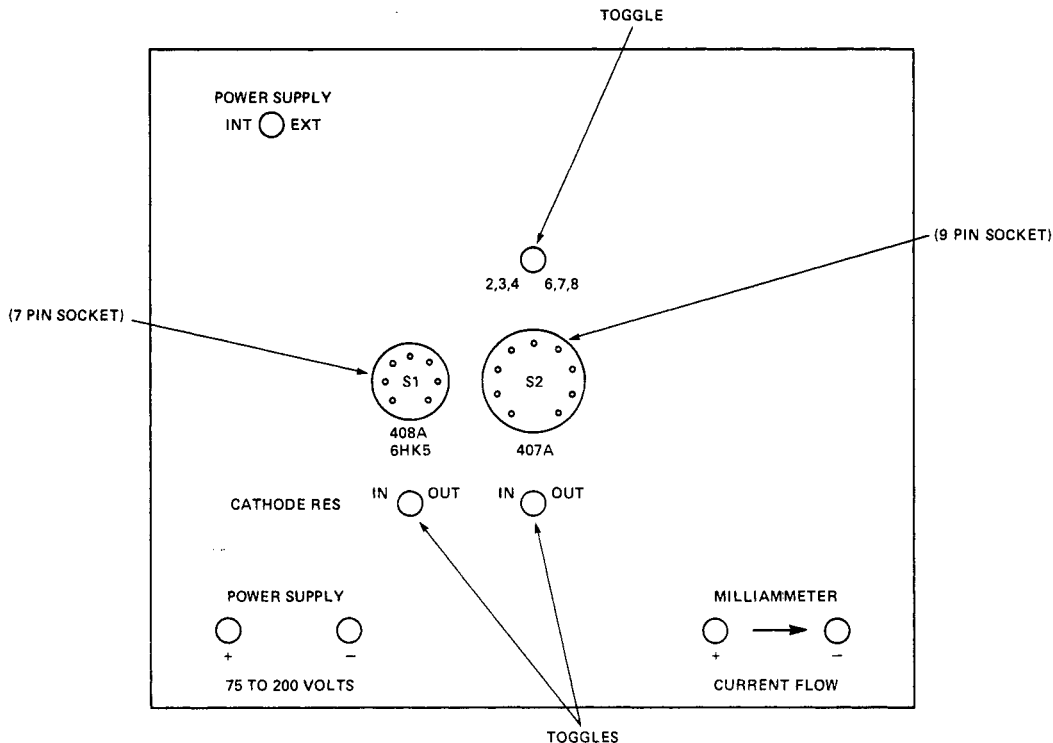

Figure 1. FETRON Test Fixture.

TABLE I.

FETRON	Tube	Idsr	gm	R _K	Side	Idsr	gm	R _K	Side	Comments	Socket
1005	407A	0.505 to 2.25	.35 Min.	240	2,3,4	3.0 to 11.0	1.8 to 6.0	240	6,7,8		S2
1008	407A	4.0 to 10.0	2.5 - 6.0	240	2,3,4	4.0 to 10.0	2.5 to 6.0	240	6,7,8		S2
1022	407A	2.0 to 6.0	2.5 Min.	240	2,3,4	2.0 to 6.0	2.5 Min.	240	6,7,8	Both sides cascoded	S2
1023	407A	.041 to 0.21	.4 Min.	240	2,3,4	.041 to 0.21	.4 Min.	240	2,3,4		S2
1024	407A	.4 to 2.0	.35 Min.	240	2,3,4	.4 to 2.0	.35 Min.	240	6,7,8		S2
1030	407A	3.0 to 10.0	2.2 - 6.0	240	2,3,4	2.0 to 5.5	1.5 Min.	240	6,7,8		S2
1032	407A	4.0 to 15.0	2.5 to 6.0	240	2,3,4	4.0 to 15.0	2.5 - 6.0	240	6,7,8		S2
1033	407A	3.6 to 7.3	3.5 Min.	240	2,3,4	3.5 - 11.0	2.0 Min.	240	6,7,8	2,3,4 = case	S2
1037	407A	0.45 to 1.37	.35 Min.	240	2,3,4	3.0 - 11.0	1.8 to 6.0	240	6,7,8		S2
1038	407A	3.0 to 11.0	1.8 to 6.0	240	2,3,4	.42 to 2.1	.35 Min.	240	6,7,8		S2
1042	407A	1.5 to 3.1	.35 Min.	"0"	2,3,4	3.0 to 11.0	1.8 to 6.0	240	6,7,8		S2
1044	407A	.41 to 2.0	0.3 to 1.0	240	2,3,4	.41 to 2.0	0.3 to 1.0	240	6,7,8		S2
1046	407A	4.0 to 15.0	2.5 to 6.0	240	2,3,4	4.0 to 15.0	2.5 to 6.0	240	6,7,8		S2
1077	407A	10 to 30	3.0 to 7.0	"0"	2,3,4	8 to 18.0	3.0 to 7.0	"0"	6,7,8	Regulator	S2

TABLE II.

FETRON	Tube	Idsr	gm	R _K	Comments	Socket
1000	408A	5.0 to 9.0	4.0 to 7.2	200	3 - 4 Sht.	S1
1001	408A	4 to 10	3.9 to 8.0	200		S1
1011	408A	4 to 10	3.5 to 7.5	200	Cathode diode	S1
1013	408A	4 to 10	3.5 to 7.5	200	6AK5	S1
1018	408A	7 to 12	3.9 to 8.0	200		S1
1029	408A	3 to 9	4.0 to 7.2	200		S1
1035	408A	5 to 9	4.0 to 7.2	200		S1
1036	408A	4 to 12	4.0 to 10.0	200		S1
1003	408A	2 to 5.5	2.5 to 7.0	200		S1
1012	408A	2 to 5.5	2.5 to 7.0	200		S1
1019	408A	2.0 Min.	3.5 Min.	200	Oscillator	S1
1049	408A	3.0 to 8.0	3.5 to 8.0	200	Also 2.5 to 6.0, 2.0 - 6.0, 200 Oscillator	S1
1004	408A	.04 to 0.2	.35 Min.	200		S1
1039	408A	.4 to 1.8	.35 Min.	200		S1
1040	408A	1.5 to 5.5	2.0 to 8.0	200		S1
1014	408A	4 to 10	1.9 to 5.9	200	Has second gate on pin 7	S1
1056	408A	4 to 10	1.9 to 5.9	200	Same as TR1014	S1

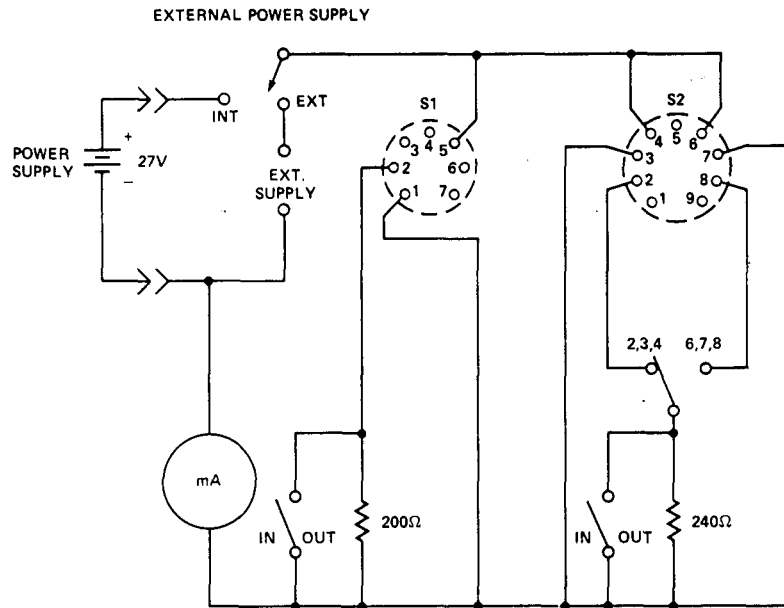

Figure 2. FETRON Test Fixture Schematic.

APPENDIX I. TRANSCONDUCTANCE MEASUREMENTS

Transconductance can be calculated from currents monitored with a simple DC FETRON tester by means of the equation:

$$g_m = \frac{I_c - I_o}{R_K}$$

Where referring to the schematic shown:

R_K is the cathode resistor.

I_o is the current with switch S open.

I_c is the current with switch S closed.

$$g_m \triangleq \frac{\Delta I_d}{\Delta V_g} \quad \therefore g_m = \frac{I_c - I_o}{I_o R_K} = \frac{I_c}{I_o} - 1$$

$I_d = I_c - I_o$ for switch alternately open and closed.

$\Delta V_g = I_o R_K$ for switch alternately open and closed since $V_g = 0$ for SW closed.

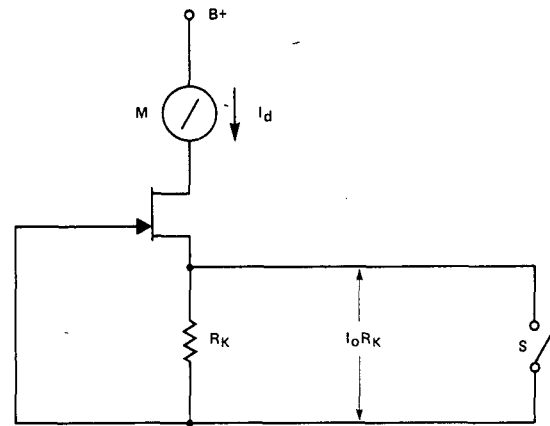

This method gives only "Large Signal" g_m and should be interpreted only as a first order approximation to small signal g_m .

TELEDYNE SEMICONDUCTOR

1300 Terra Bella Avenue, Mountain View, Ca. • Tel. (415) 968-9241 • TWX: 910-379-6494 • Telex: 34-8416

Chausse de la Hulpe 181, 1170 Brussels, Belgium • Tel. (32) (2) 72 99 88 • Telex: 25881

Albert Gebhardtstrasse 32, 7897 Tiengen, West Germany • Tel. (49) (7741) 5066 • Telex: 7921462

Heathrow House, Bath Road, Cranford, Middlesex, England • Tel. (44) 01-897-2501 • Telex: UPQ 935008

Nihon Seimei-Akasaka Bldg. (3F), 1-19, Akasaka 8-chome, Minato-ku, Tokyo 107, Japan • Tel. 03 405 5738 • Telex: 2424241 TPJ J

Teledyne Semiconductor cannot assume responsibility for use of any circuitry described other than circuitry embodied in a Teledyne product. No other circuit patent licenses are implied.

FETRON[®] Instrument Conversion Kits

HP400 Voltmeter
Tektronix Oscilloscope CA Plug-in Module

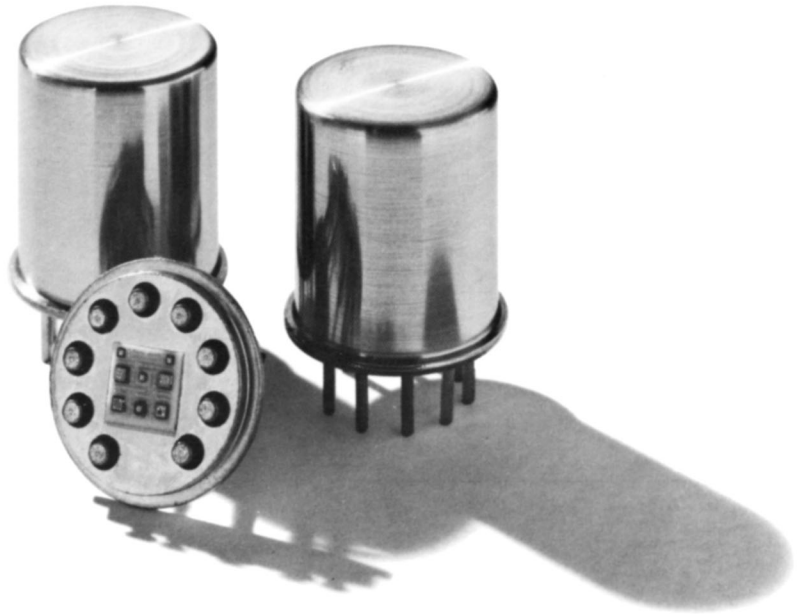

New Life for Old Instruments

A sure cure for vacuum-tube aging and associated reliability problems in instruments, and for the resulting calibration, maintenance and inventory expenses, is a FETRON[®] solid-state tube conversion kit from Teledyne Semiconductor.

FETRONs are hybrid integrated circuits that replace vacuum tubes. They use cascoded JFETs (junction field-effect transistors) to duplicate the transfer characteristics of specific types of vacuum tubes. And FETRON metal-can packages plug directly into vacuum tube sockets.

Because FETRONs are solid-state, they have essentially the same stability, low-noise characteristics and reliability as high-quality bipolar transistors.

Communications companies are using FETRONs in large quantities to improve existing tube equipment. Now for the instrument owner, Teledyne has developed off-the-shelf conversion kits. Each is a set of FETRONs designed to replace the tubes in widely used instruments.

At present, FETRON conversion kits are available at a fraction of the cost of a new instrument to upgrade the HP400 VTVM and the CA plug-in module for Tektronix 500 series oscilloscopes.

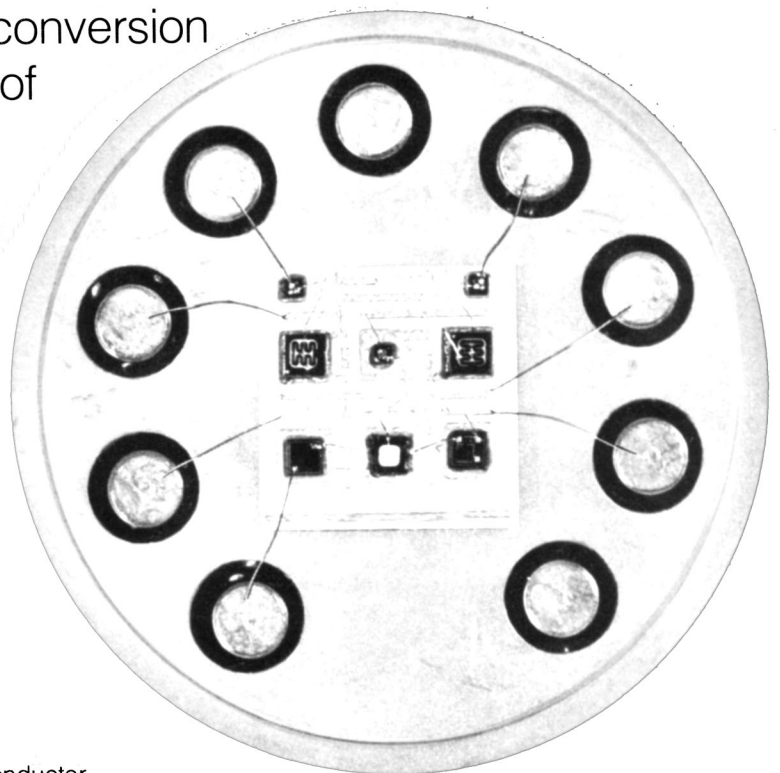

Solid-State Stability and Reliability

By retrofitting with FETRON conversion kits from Teledyne, you can extend the useful life of a vacuum-tube instrument many years and stretch out calibration intervals beyond 12 months.

Improved Accuracy. FETRONs never drift, but vacuum tubes begin drifting immediately causing greater errors between calibrations. With FETRONs, periodic calibration is required only as a check for malfunctions.

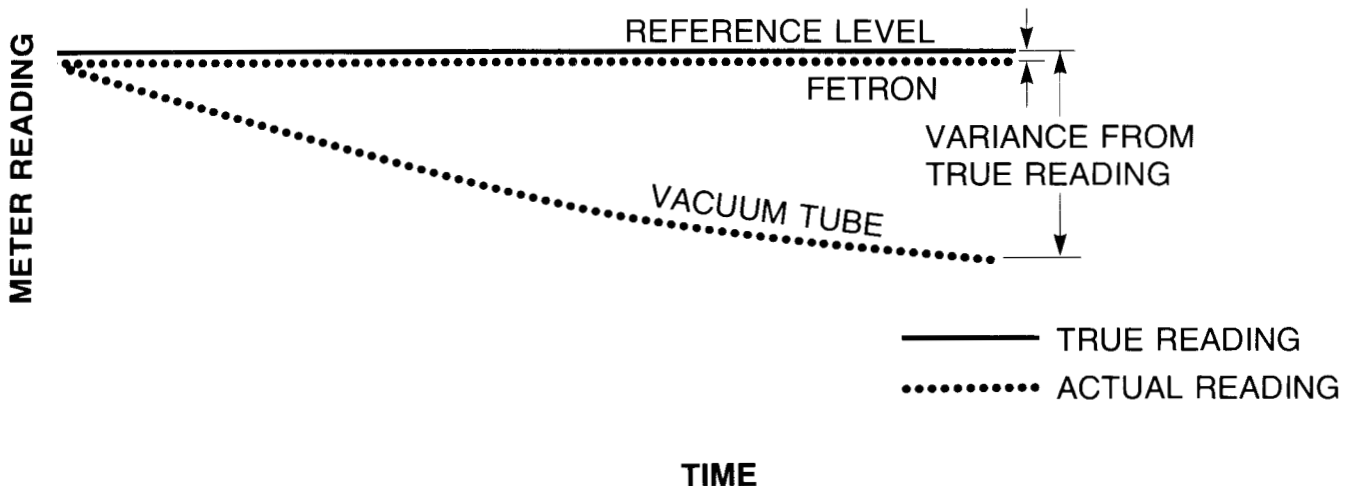

The graph shows the difference in stability between vacuum tubes and FETRONs, as measured on a VTVM before and after conversion. Since drift is eliminated, the normal three-month recalibration cycle can be replaced by a cycle of 12 months or longer, with occasional bench checks to make sure the instrument is functioning properly.

Being solid-state, FETRONs are not subject to tube degradation modes, such as gassiness, microphonics and filament deterioration, that upset measurement accuracy. What's more, FETRONs are immune to shock and vibration levels that could damage tubes, and they have many, many times the operating lifetime of tubes. They also improve the overall reliability of the instrument because they run cool, without heater power.

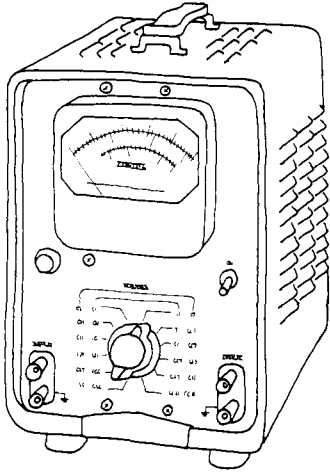

HP400 Conversion Kit

The HP400 conversion kit replaces the five amplifier circuit tubes of the HP400 VTVM. Conversion consists of removing the tubes, plugging in the FETRONs, and recalibrating the instrument with step-by-step procedures given in the instruction booklet.

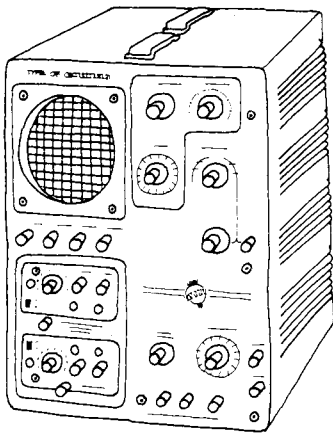

CA Plug-in Conversion Kit

This kit replaces all 15 tubes in the CA plug-in module for Tektronix 500 series oscilloscopes. In addition to replacing the tubes, minor wiring changes are required. An instruction booklet details the conversion steps.

TELEDYNE SEMICONDUCTOR

1300 Terra Bella Avenue, Mountain View, Ca. • Tel. (415) 968-9241 • TWX: 910-379-6494 • Telex: 34-8416
Chausse de la Hulpe 181, 1170 Brussels, Belgium • Tel. (32) (2) 72 99 88 • Telex: 25881
Albert Gebhardtstrasse 32, 7897 Tiengen, West Germany • Tel. (49) (7741) 5066 • Telex: 7921462
Heathrow House, Bath Road, Cranford, Middlesex, England • Tel. (44) 01-897-2501 • Telex: UPQ 935008
Nihon Seimei-Akasaka Bldg. (3F), 1-19, Akasaka 8-chome, Minato-ku, Tokyo 107, Japan • Tel. 03 405 5738 • Telex: 2424241 TPJ J